

# HENDERSON



Sliding and Folding Door Hardware  
**The Complete Product Range**





# HENDERSON

Making things slide since 1921

**Established in 1921, P C Henderson has been creating the highest quality sliding and folding door hardware for over 90 years. Our products can be seen in a wide variety of residential, commercial and industrial applications across the world.**

Our expertly designed hardware systems are perfect for saving space, increasing natural light, creating flexible spaces and providing hardwearing solutions for virtually any type of application.

Applications include wardrobe & cupboard doors, pocket doors, internal doors, exterior doors, room dividers, office partitions, shop fronts, large industrial doors as well as bespoke systems. Wherever a sliding or folding door can work, we offer a solution.

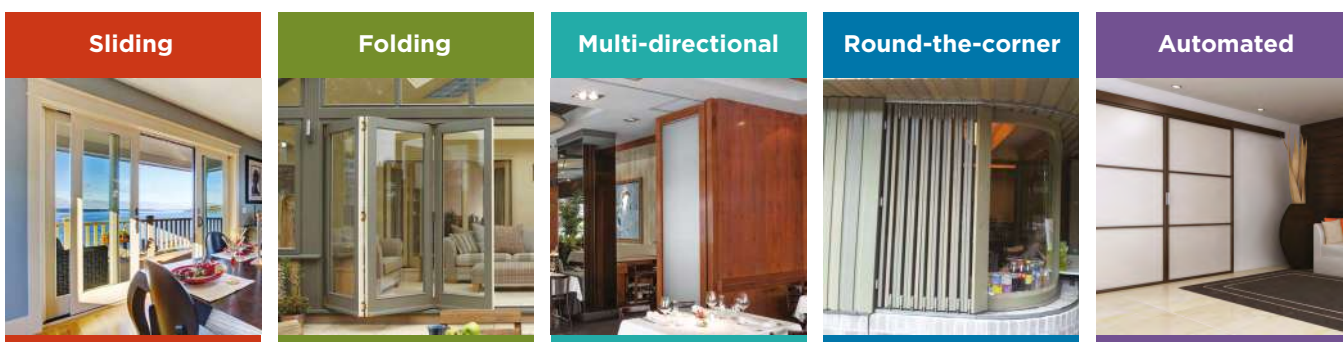

Based in Co. Durham, UK our manufacturing plant is one of the most advanced of its kind, constantly achieving strict ISO 9001 quality standards. We also have offices in Ireland, the Netherlands and China along with an extensive network of distributors and representatives across the globe, exporting to over 70 countries worldwide.



For over 95 years P C Henderson has been providing a wide range of high quality, value for money sliding and folding door hardware, backed up by exceptional customer service and unrivalled expertise.

# CONTENTS

Sliding					
Product	Application	Door Material	Door Weight Position	Max. Door Weight	Page No.
<b>Slipper</b>	Interior	Wood	Top Hung	9kg	10
<b>Loretto</b>	Interior	Wood	Bottom Rolling	23kg	11
<b>Cello</b>	Interior	Wood	Bottom Rolling	25kg	12
<b>Zenith</b>	Interior	Glass	Bottom Rolling	25kg	13
<b>Senator</b>	Interior	Wood	Top Hung	30kg	14
<b>Phantom</b>	Interior	Wood	Top Hung	45kg	15
<b>Single Top</b>	Interior	Wood	Top Hung	45kg	16
<b>Double Top</b>	Interior	Wood	Top Hung	45kg	17
<b>Mansion 55</b>	Interior	Wood	Bottom Rolling	55kg	18 - 19
<b>Pocket Door</b>	Interior	Wood	Top Hung	60kg	20 - 21
<b>Husky Glass</b>	Interior	Glass	Top Hung	50kg/75kg	22 - 23
<b>Husky Telescopic</b>	Interior	Wood	Top Hung	80kg	24
<b>Sirocco</b>	Interior	Wood/Metal	Top Hung	80kg	25
<b>Rustic 80</b>	Interior	Wood/Metal	Top Hung	80kg	26 - 27
<b>Velaro</b>	Interior	Glass	Top Hung	80kg	28
<b>Marathon</b>	Interior	Wood	Top Hung	55kg/90kg	29
<b>Husky Sliding</b>	Interior	Wood/Metal	Top Hung	50kg/100kg	30 - 31
<b>Universal Telescopic</b>	Interior	Wood	Top Hung	80kg/120kg	32
<b>Sienna</b>	Interior	Wood	Top Hung	120kg	33
<b>Sienna Glass</b>	Interior	Glass	Top Hung	120kg	34
<b>Pacer Glass</b>	Interior	Glass	Top Hung	130kg/180kg	35 - 37
<b>Pacer Sliding</b>	Interior/Exterior	Wood/Metal	Top Hung	200kg	38 - 39
<b>Imperial</b>	Interior/Exterior	Wood/Metal	Bottom Rolling	100kg/200kg	40 - 41
<b>Soltaire</b>	Interior/Exterior	Wood/Metal	Top Hung	120kg/180kg/250kg	42 - 43
<b>Stainless Steel</b>	Interior/Exterior	Wood/Metal	Top Hung	50kg/100kg/150kg/270kg	44 - 45
<b>Majestic</b>	Interior/Exterior	Wood	Bottom Rolling	270kg	46 - 47
<b>Flexirol Sliding</b>	Interior/Exterior	Wood/Metal	Top Hung	500kg	48 - 49
<b>Flexirol Sliding Glass</b>	Interior	Glass	Top Hung	500kg	50 - 51
<b>Straight Sliding 290, 301, 301H, 305, 307</b>	Interior/Exterior	Wood/Metal	Top Hung	150kg/200kg/300kg/400kg/450kg/700kg/2000kg	52 - 55
<b>Sterling</b>	Interior/Exterior	Wood/Metal	Bottom Rolling	350kg/800kg/2000kg/ 3600kg/8000kg	56 - 58
<b>Overhead Runway Gear</b>	Interior/Exterior	-	Top Hung	Variety of door weights	59

Folding					
Product	Application	Door Material	Door Weight Position	Max. Door Weight	Page No.
<b>Bifold</b>	Interior	Wood	Top Hung	14kg	62
<b>Roomflex</b>	Interior	Wood	Top Hung	35kg/50kg	63
<b>Husky Folding</b>	Interior	Wood	Top Hung	25kg/40kg	64 - 65
<b>Pacer Endfold</b>	Interior	Wood/Metal	Top Hung	35kg/65kg	66 - 67
<b>Tangent Folding</b>	Interior/Exterior	Wood/Metal	Top Hung	35kg/55kg/70kg	68 - 69
<b>Pacer Centrefold</b>	Interior	Wood	Top Hung	35kg/75kg	70 - 71
<b>Soltaire Endfold</b>	Interior	Wood/Metal	Top Hung	45kg/75kg	72 - 73
<b>Soltaire Centrefold</b>	Interior	Wood/Metal	Top Hung	45kg/75kg	74 - 75
<b>Securefold Bottom Rolling</b>	Interior/Exterior	Wood	Bottom Rolling	80kg	76 - 79
<b>Council Centrefold</b>	Interior	Wood	Top Hung	35kg/55kg/70kg/80kg	80 - 81
<b>Council Endfold</b>	Interior	Wood	Top Hung	35kg/55kg/70kg/80kg	82 - 83
<b>Flexirol Endfold</b>	Interior/Exterior	Wood/Metal	Top Hung	125kg	84 - 86
<b>Flexirol Centrefold</b>	Interior	Wood	Top Hung	125kg	87
<b>College Centrefold</b>	Interior	Wood	Bottom Rolling	70kg/140kg	88 - 89
<b>College Endfold</b>	Interior	Wood	Bottom Rolling	70kg/140kg	90 - 91
<b>Securefold</b>	Interior/Exterior	Wood	Top Hung	50kg/100kg/150kg	92 - 96



Multidirectional					
Product	Application	Door Material	Position of Door Weight	Max. Door Weight	Page No.
<b>Flexirol Multidirectional</b>	Interior/Exterior	Wood/Metal	Top Hung	100kg/500kg	98 - 99
<b>Flexirol Multidirectional Glass</b>	Interior	Glass	Top Hung	100kg/250kg/500kg	100 - 102

Round the Corner					
Product	Application	Door Material	Position of Door Weight	Max. Door Weight	Page No.
<b>Tangent Round the Corner</b>	Interior/Exterior	Wood/Metal	Top Hung	35kg/55kg/70kg	104 - 105

Automated					
Product	Application	Door Material	Position of Door Weight	Max. Door Weight	Page No.
<b>Evolve</b>	Interior	Wood/Glass	Top Hung	40kg/60kg/80kg	108 - 110

Door Configurations and Quantities					Page No.
<b>Interior Centre Folding Systems</b>					112
<b>Interior End Folding Systems</b>					113 - 116

Component Drawings					Page No.
<b>Tracks, Intersects and Curves</b>					117
<b>Brackets</b>					117
<b>Hangers/Rollers</b>					118
<b>Pivots</b>					119
<b>Guides</b>					119
<b>Guide Channels</b>					119
<b>Accessories and Stops</b>					119

Industrial Component Drawings					Page No.
<b>Tracks</b>					120
<b>Brackets</b>					121
<b>Hangers</b>					122
<b>Channels and Rails</b>					123

Stainless Steel Component Drawings					Page No.
<b>Track, Guide Channel and Guides</b>					124
<b>Brackets and Stops</b>					125
<b>Hangers</b>					126

Accessories					Page No.
<b>Soft Close Kits</b>					127
<b>Simultaneous Action Kits</b>					127
<b>Self-Closing Door Kits</b>					127
<b>Low Headroom Kits</b>					128
<b>Fire Door Kits</b>					128
<b>Flush Pulls</b>					128
<b>Handles</b>					129
<b>Door Stops</b>					129
<b>Track Stops</b>					129
<b>Clip Stops</b>					130
<b>Door Magnets</b>					130
<b>Flush Bolts</b>					130
<b>Locks</b>					131
<b>Bolts</b>					131
<b>Automatic Door Accessories</b>					131
<b>Fascia</b>					132

# WHY P C HENDERSON

## Our People

Our customer service and technical support team is made up of a group of knowledgeable, passionate and long standing individuals. With extensive experience working on projects of all sizes across the world, the team possess the knowledge and experience required to specify even the most complex and ambitious of projects.



## Impressive Product Range

From small 9kg sliding hatch doors to 8000kg large industrial doors - our range of hardware caters for projects of all sizes. With over 60 different hardware products, 5 different styles of mechanism, interior and exterior options, top hung and bottom rolling support options, along with a huge range of accessories - our vast product range is one to be surpassed. Wherever a sliding or folding door can work, we offer a solution.

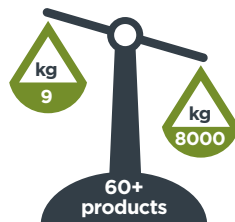

## Designing and Manufacturing Since 1921

As a designer and manufacturer of sliding door hardware since 1921, it's safe to say that our expertise in this area is one to be rivalled with. Our offices, people, technology, materials and tooling may have all changed over the course of almost a century but the Henderson ethos of how we design and manufacture our products has remained the same and is testament to our success today. P C Henderson manufactures to strict quality standards of ISO9001:2008.



## Research and Development

Continual investment into the research and development of our product range is extremely important. Part of this research is customer engagement - hearing the voice of the customer first hand is vital to the success of our products. We use this valuable feedback to continually adapt, enhance and add to our existing product range to make sure we meet and exceed customer expectations.

## Product Testing

Our in house, state of the art testing facilities allows us to put each and every one of our products through rigorous testing prior to release. Each component we design is put through a Finite Element Analysis, this process applies virtual forces to the product to see where modifications may be required before the product is even built. A prototype is then built for a physical test, each of our products are tested continuously, using specialist machinery in excess of 100,000 cycles, to ensure they are capable of withstanding the test of time.



## Environmental Commitment

P C Henderson is committed to achieving and demonstrating compliance with all relevant environmental laws, regulations and standards. We also take our responsibilities to society extremely seriously. Our ISO 14001 accredited environmental policy sets out our commitment to providing products and services that are environmentally sound.



# CHOOSE YOUR HARDWARE

## USING OUR SIMPLE 10 STEP GUIDE

- 1 Internal or external use?
- 2 How will it operate?
- 3 Is the door top hung or bottom rolling?
- 4 Face fixed or soffit fixed track?
- 5 How heavy are the doors?
- 6 What door material is being used?
- 7 Are the doors within the opening?
- 8 What is the opening width?
- 9 Choose your product
- 10 Choose your accessories

# EXPERT SPECIFICATION TOOL

Our online Expert Specification Tool will guide you through a number of questions in order to gather all of the information required to specify your hardware. It will then produce a short list of suitable products for you to choose from – simple and easy. [www.pchenderson.com/expert2](http://www.pchenderson.com/expert2)

The image displays six screenshots from the Henderson Expert Specification Tool, arranged in a 2x3 grid. Each screenshot shows a step in the selection process:

- Step 1:** "Select exterior or interior". The question is "Will the sliding door gear be exposed to the elements?". It offers two options: "Exterior" (with a diagram of a door with exposed gears) and "Interior" (with a diagram of a door with hidden gears).
- Step 2:** "Choose the type of gear". The question is "Which type of sliding door gear do you require?". It offers three options: "Straight sliding", "Pin folding" (selected), and "Round the corner".
- Step 3:** "Select top hung or bottom roller". The question is "How will the weight of the door be supported?". It offers two options: "Top hung" (with a diagram of a door hanging from a track) and "Bottom roller" (with a diagram of a door on rollers).
- Step 4:** "How will the track be fixed?". The question is "Face fixed or soffit fixed?". It offers two options: "Face fixed" (with a diagram of a track mounted on the wall) and "Soffit fixed" (with a diagram of a track mounted in the ceiling).
- Step 5:** "Enter the dimensions". The question is "What is the size of the opening?". It asks for "Opening width", "Opening height", "Left reveal", and "Right reveal" in millimeters, with input fields provided.
- Step 6:** "Door configuration". The question is "End folding system". It offers three options: "Hinged to left post", "Floating", and "Hinged to right post". It also includes a "Number of folding units" dropdown and "Unit" selection (e.g., "4 LEAVES").



# OUR BROCHURE

The entire P C Henderson product range in an easy to follow format

## Product Comparison Table

Our contents table on pages 4 and 5 also doubles up as a handy comparison table for easy browsing of our entire product range.

## Sections by Operation Type

The brochure is broken down into five sections for easy browsing; sliding, folding, multidirectional, round the corner and automated. These are colour coded for ease of navigation.



## Products in Door Weight Order

Within each of the 5 sections of the brochure, the products are listed in door weight order.

If the hardware you're looking for will be used to carry lighter doors, start at the beginning of the section, if it will be carrying heavy doors move to the back of the section.

## Handy Product Overview Boxes

Operation, door weight, application type and door material - it's all covered in the handy product overview boxes at the top of each page.



## Detailed Technical Information

Each of our specified products contain a wealth of technical information and drawings to help specify and put together the right solutions for your project. Additional technical information such as CAD drawings, datasheets and fitting instructions can be found on our website.

## Kit Packs

Some of our residential and light commercial products are available in a handy kit pack format. This allows you to purchase 'off the shelf' without having to specify individual parts and components.

Look out for our handy kit pack symbol in the top corner of each page.

## Installation Videos

The majority of our kit packs come with a handy online installation video to guide you along the process. Look out for the video symbol at the bottom of our kit pack product pages.

You can view the installation videos by typing in the web address or by scanning the QR code using your phone.



Watch our installation videos at [www.pchenderson.com/installation-videos](http://www.pchenderson.com/installation-videos)



## Brochure Notes

- All dimensions supplied are in mm
- Any screws supplied are wood screws
- Most systems can be specified to unique requirements, contact our technical team for details



# Sliding Doors



Catering for a maximum door weight of between 9kg and 8000kg our wide range of sliding door hardware can cater for virtually any type of application or design.

For residential and commercial applications, sliding doors are a great way to save space, create seamless indoor/outdoor flows, increase natural light and provide easy access. For industrial applications such as factories, warehouses, agricultural settings and large sliding gates – robust hardware and high levels of security is key.

Available in single sliding, pocket door, bi-parting, telescopic, top hung or bottom rolling variations, our hardware offers huge versatility in terms of functionality and design. Equally as important, the systems are available in a vast array of quality aesthetic finishes and styles whether that be for a sleek and modern design or perhaps a more traditional and period look.

## Range Overview

- Over 30 different systems
- Catering for maximum door weights of between 9kg and 8000kg
- Catering for wood, metal or glass doors
- Interior and exterior applications
- Top hung and bottom rolling options

[www.pchenderson.com](http://www.pchenderson.com)

# SLIPPER

For sliding wooden cupboard or hatch doors weighing up to 9kg



Slipper is ideally suited for hatches, cupboards and other items made from lightweight wood or chipboard. It supports a maximum door weight of 9kg, a maximum door width of 900mm and door thickness of between 16-30mm. Three kits are available giving a maximum opening width of 1800mm and the unit can easily be top fixed. The nylon sliders and aluminium track combine quiet and effortless operation, an appealing design and simple-to-remove doors for cleaning and decorating. A fittings kit is available for when an additional door is required.

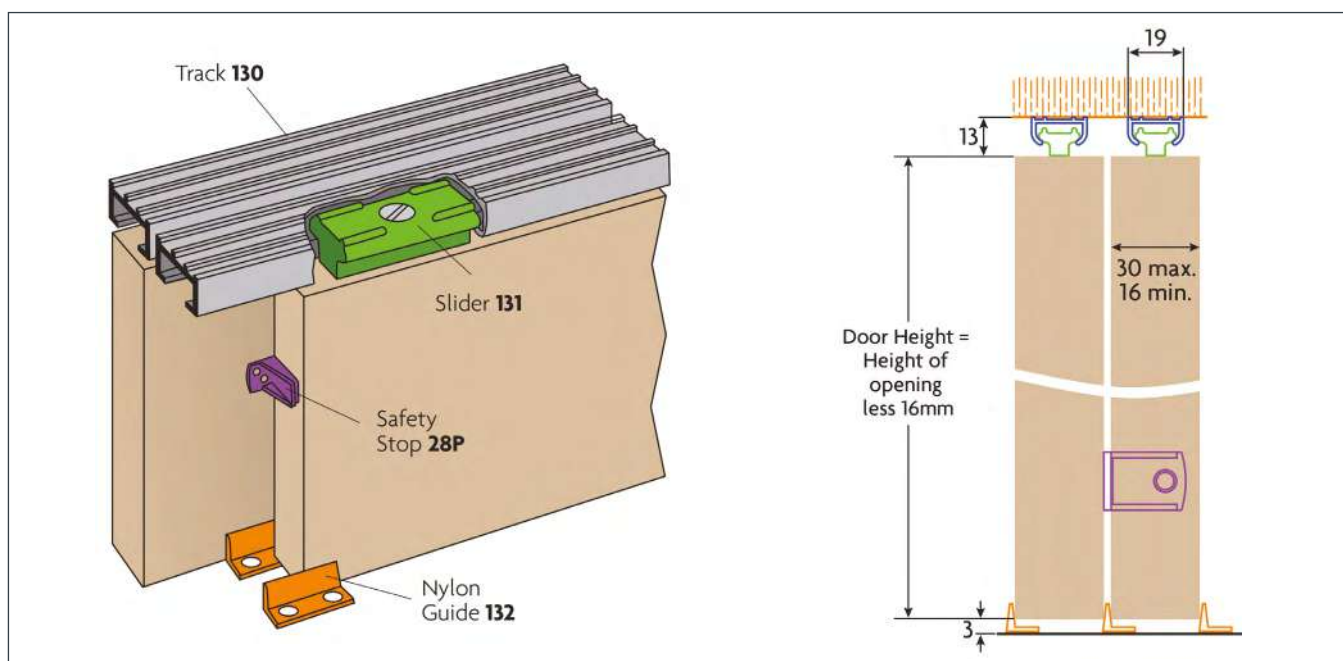

## Product Information

Kit Order Code	No. of Doors	Track Length	Max. Door Height	Max. Door Width	Door Thickness Range	Max. Door Weight
SS4	2	1200mm	1800mm	900mm	16 - 30mm	9kg
SS5	2	1500mm	1800mm	900mm	16 - 30mm	9kg
SS6	2	1800mm	1800mm	900mm	16 - 30mm	9kg
SS1	Fittings Kit to be used when an additional door is required					

## Kit Contents

Component	Short Code
Track (x 2)	130/****
Sliders (x 4)	131
Stop (x 1)	28P
White Plastic Flushpull (x 2)	26P
Nylon Guide (x 4)	132

## Accessories



1 Door Fittings Kit (**SS1**)

**View our full range of door handles and flush pulls on pages 128 and 129.**

\*\*\*\* replace by length of track for full short code





# LORETTO

For sliding wooden cupboard doors weighing up to 23kg



When it comes to wardrobes, cupboards, bookcases and other pieces of high quality cabinet work, Loretto is the ideal system. It has been designed to cater for wooden doors weighing up to 23kg, 900mm wide and 20-45mm thick. Using nylon guides and rollers on an aluminium rail, this system is incredibly smooth and quiet. Available in three kits with a maximum opening width of 1800mm.

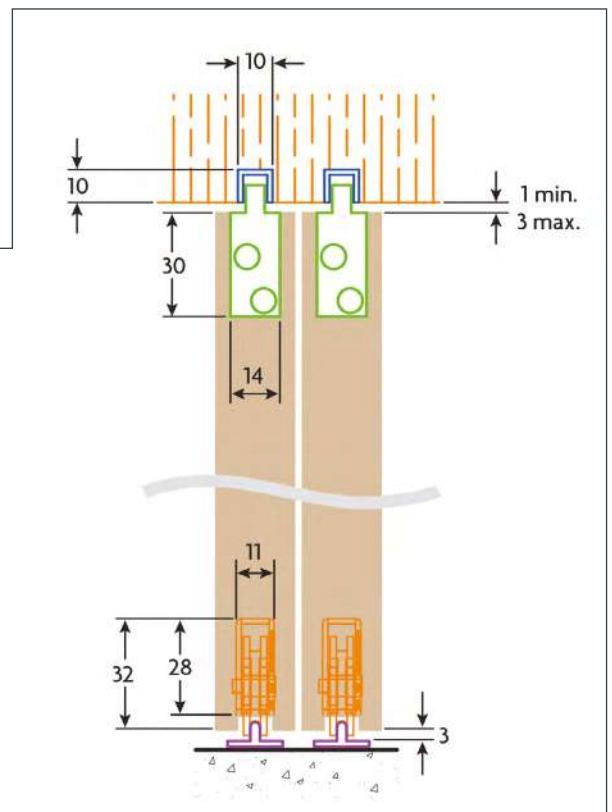
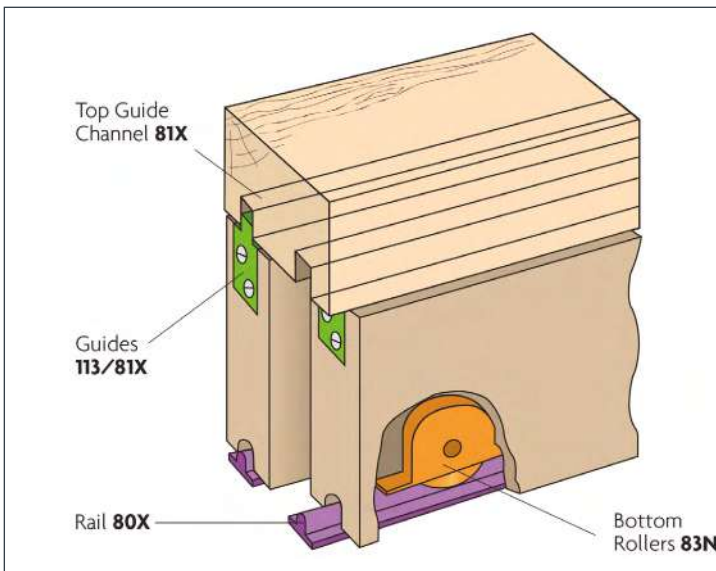

## Product Information

Kit Order Code	No. of Doors	Track Length	Max. Door Height	Max. Door Width	Door Thickness Range	Max. Door Weight
D4	2	1200mm	1800mm	900mm	20 - 45mm	23kg
D5	2	1500mm	1800mm	900mm	20 - 45mm	23kg
D6	2	1800mm	1800mm	900mm	20 - 45mm	23kg

## Kit Contents

Component	Short Code
Top Guide Channel (x 2)	81X/****
Top Guides (x 4)	113/81X
Mortise Fixed Bottom Rollers (x 4)	83N
Bottom Rail (x 2)	80X/****

## Accessories

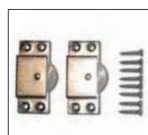

Face Fixed Bottom Rollers (84N)



Door Stop (28P)

View our full range of door handles and flush pulls on pages 128 and 129.

\*\*\*\* replace by length of track for full short code



# CELLO

For sliding wardrobe and cupboard doors weighing up to 25kg



Cello is the perfect system for wooden wardrobe or cupboard doors weighing up to 25kg each. It can support doors up to 2400mm high, 920mm wide and between 16 - 40mm thick. Two and three door kits are available in order to create opening widths of up to 2400mm. A fittings kit is also available for when an additional door is required.

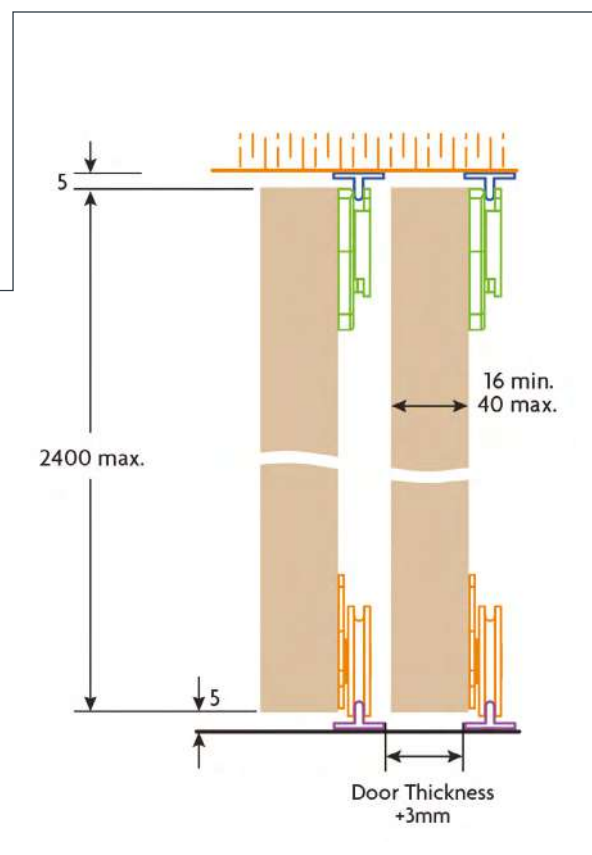
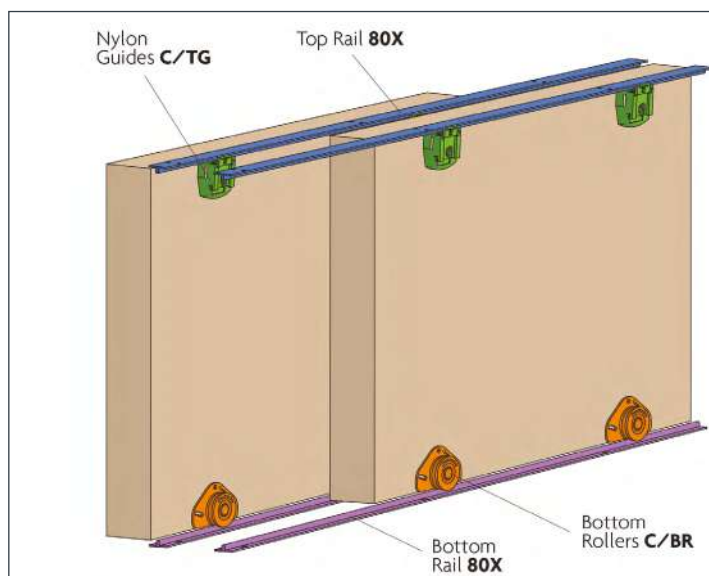

## Product Information

Kit Order Code	No. of Doors	Track Length	Max. Door Height	Max. Door Width	Door Thickness Range	Max. Door Weight
C15	2	1500mm	2400mm	920mm	16 - 40mm	25kg
C18	2	1800mm	2400mm	920mm	16 - 40mm	25kg
C24	3	2400mm	2400mm	920mm	16 - 40mm	25kg
C1	Fittings Kit to be used when an additional door is required					

## Kit Contents

Component	Short Code
Bottom Rail (x 4)	80X/****
Top Guide (x 4 for 2 doors/x 3 for 3 doors)	C/TG
Bottom Roller (x 4 for 2 doors/x 3 for 3 doors)	C/BR

\*\*\*\* replace by length of track for full short code

## Accessories



Easyclose Automatic Door Closer (SC100)



Door Stop (28P)

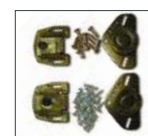

1 Door Fittings Kit (C1)

View our full range of door handles and flush pulls on pages 128 and 129.



# ZENITH

For sliding glass cupboard doors weighing up to 25kg



Zenith is the perfect partner for any showcase, bookcase, display unit, hatch or interior window which utilises glass doors weighing up to 25kg and measuring 6mm thick. Three kits are available to give a maximum opening width of 1800mm. The system uses precision-made, satin anodised finish aluminium gear and brush- pile strips to ensure a silent and easy-gliding action.

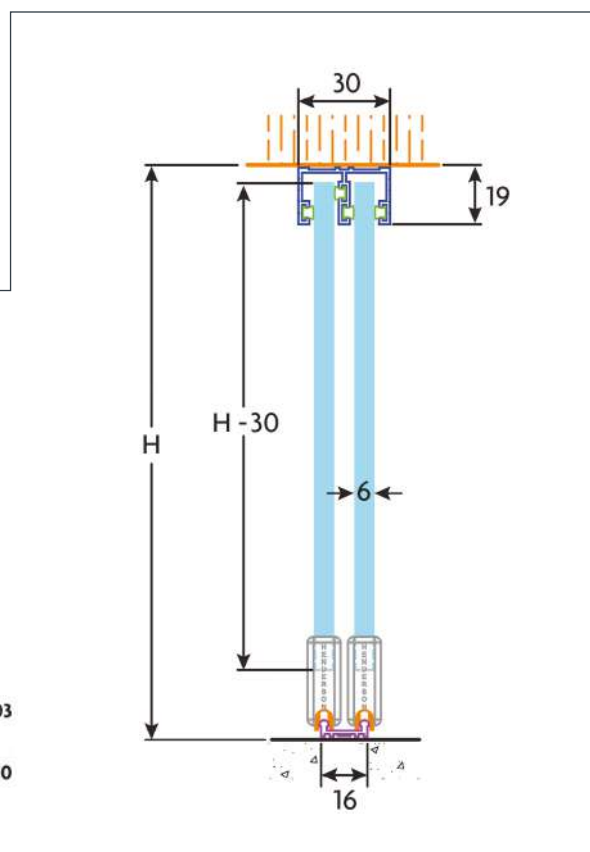
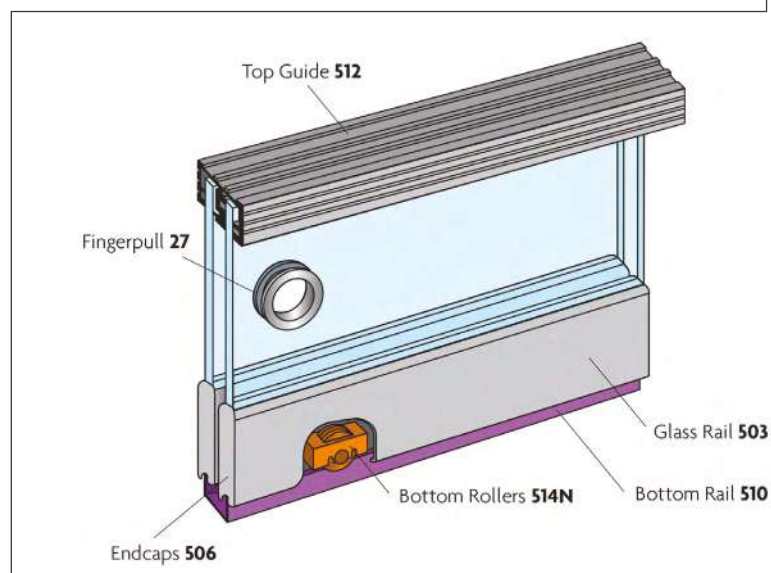

## Product Information

Kit Order Code	No. of Doors	Track Length	Max. Door Height	Max. Door Width	Door Thickness Range	Max. Door Weight
Z12	2	1200mm	1800mm	916mm	6mm	25kg
Z15	2	1500mm	1800mm	916mm	6mm	25kg
Z18	2	1800mm	1800mm	916mm	6mm	25kg

## Kit Contents

Component	Short Code
Top Guide Channel (x 1)	512/****
Glass Rails (x 2)	503
Bottom Rollers (x 4)	514N
Endcaps (x 4)	506
Bottom Rail (x 1)	510/****
Glazing Strip (x 2)	509

\*\*\*\* replace by length of track for full short code

## Accessories



Cylinder Lock (507)

**View our full range of door handles and flush pulls on pages 128 and 129.**





# SENATOR

An elegant sliding door mechanism for doors weighing up to 30kg



Senator offers an elegant sliding mechanism for entrance doors and room dividing wooden doors up to 30kg in weight, 900mm wide and between 20-35mm thick. Nylon guides and hangers on an aluminium track with useful fixed floor guides complete this premium package.

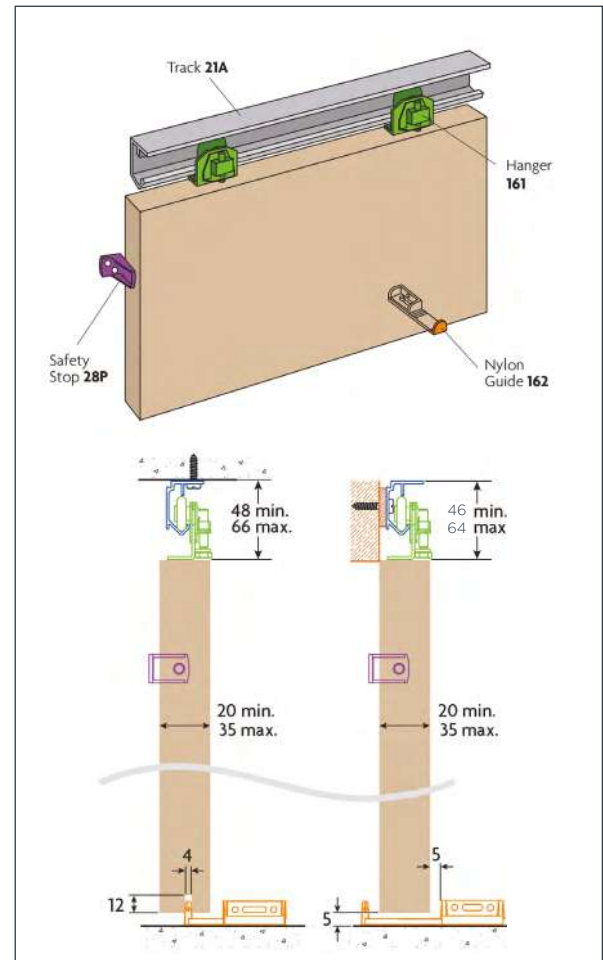

## Product Information

Kit Order Code	No. of Doors	Track Length	Max. Door Height	Max. Door Width	Door Thickness Range	Max. Door Weight
SEN	1	1500mm	2400mm	900mm	20 - 35mm	30kg

## Kit Contents

Component	Short Code
Jump Proof, Face/Soffit Fixing Track (x 1)	21A/1500
Top Fixing Hangers (x 2)	161
Nylon Guide (x 1)	162
Stop (x 1)	28P

## Accessories



Easyclose Automatic Door Closer (**SC100**)



Galvanised Steel Fascia (**40P/1850**)



Galvanised Steel Fascia Endcap (**EC40P**)

View our full range of door handles and flush pulls on pages 128 and 129.



# PHANTOM

For sliding wooden room dividers weighing up to 45kg



If a silent sliding mechanism is a priority, Phantom really delivers. Made for wooden doors weighing up to 45kg, between 610 - 915mm wide and 30 - 50mm thick, it can effortlessly divide virtually any room in a variety of environments. Phantom is ultra-quiet, frictionless and easy to operate. Two kits can be used to create a double door specification.

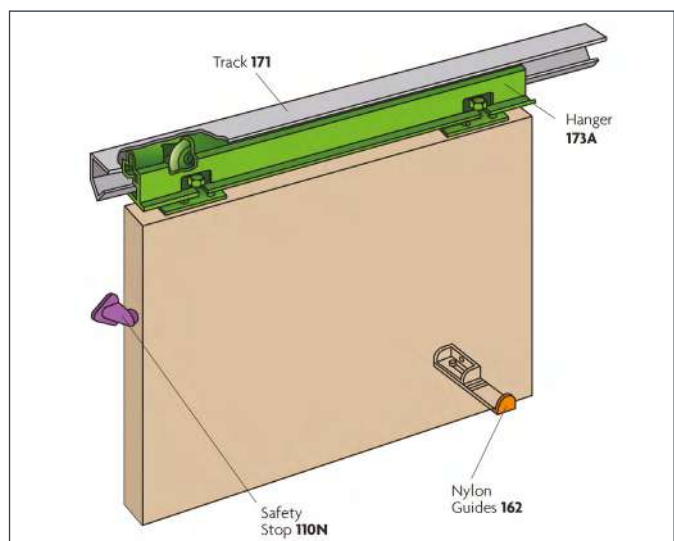

## Product Information

Kit Order Code	No. of Doors	Track Length	Max. Door Height	Max. Door Width	Door Thickness Range	Max. Door Weight
P9	1	1525mm	2400mm	915mm	30 - 50mm	45kg

## Kit Contents

Component	Short Code
Soffit Fixed Track (x 1)	171
Hanger (x 1)	173A
Nylon Guide (x 1)	162
Stop (x 1)	110N

## Accessories

Floor Mounted Stop (103)	Galvanised Steel Fascia (40P/1850)	40P End Cap Pack (EC40P)	Easyclose Automatic Door Closer (SC100)	Soffit Fixed Brackets x 5 (3/40)

View our full range of door handles and flush pulls on pages 128 and 129.



# SINGLE TOP

For single sliding wardrobe and cupboard doors weighing up to 45kg



With Single Top, wardrobe doors have never been more graceful. The system works with a single track for wooden wardrobe doors of up to 45kg and between 16-40mm. Three kits are available for a maximum width of 900mm.

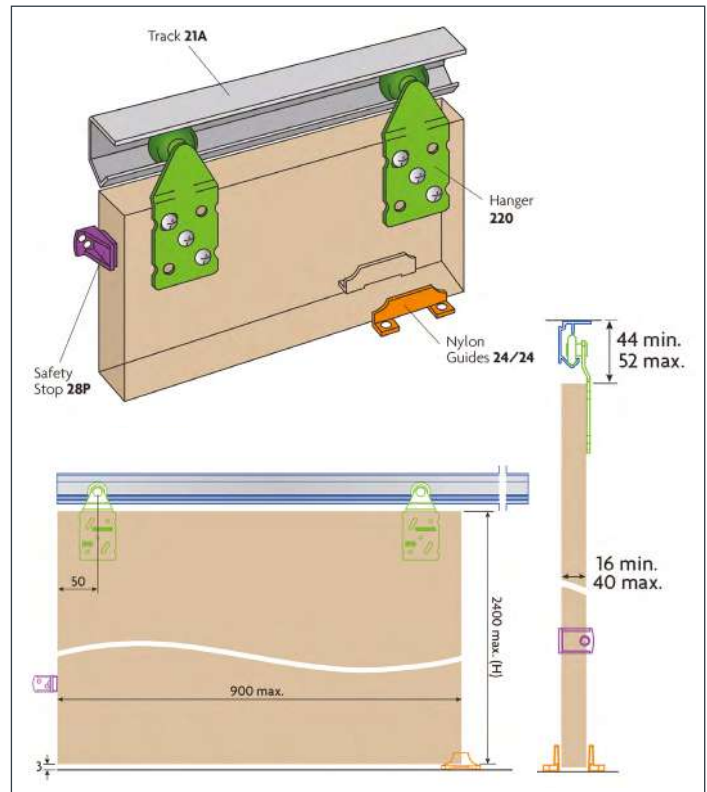

## Product Information

Kit Order Code	No. of Doors	Track Length	Max. Door Height	Max. Door Width	Door Thickness Range	Max. Door Weight
ST12	1	1200mm	2400mm	600mm	16 - 40mm	45kg
ST15	1	1500mm	2400mm	750mm	16 - 40mm	45kg
ST18	1	1800mm	2400mm	900mm	16 - 40mm	45kg
ST01	Fittings Kit to be used when an additional door is required					

## Kit Contents

Component	Short Code
Anti-Rise, Face/Soffit Fixed Aluminium Track (x 1)	21A/****
Face Fixed Hangers (x 2)	220
Rubber Buffered Stop (x 1)	28P
Nylon Guide (x 1)	24/24

\*\*\*\* replace by length of track for full short code

## Accessories



Fascia (**F134/\*\*\*\***) for doors up to 30mm thick



F134 End Cap Pack (**F134/ECP**)



Fascia (**F138/\*\*\*\***) for doors up to 25mm thick



F138 End Cap Pack (**F138/ECP**)



Guide Channel (**81X/\*\*\*\***) when a floor mounted guide is required



Guides for 81X Channel (**113/81X**) 2 per door



1 Door Fittings Kit (**ST01**)

**View our full range of door handles and flush pulls on pages 128 and 129.**





# DOUBLE TOP

For sliding wooden bi-passing wardrobe doors weighing up to 45kg

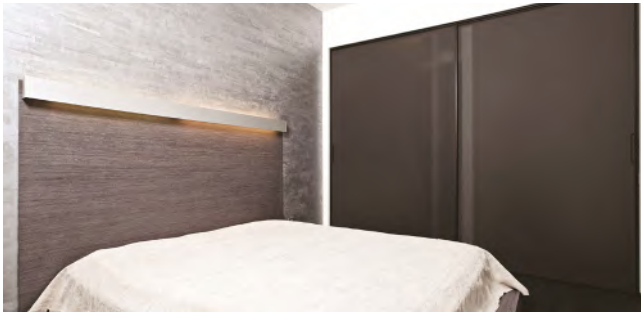

Double Top is perfectly suited for heavy duty sliding wardrobe or cupboard doors. Designed to support double track sliding wooden doors weighing up to 45kg and 16-40mm thick, the quiet system works on nylon hangers and an aluminium track. Door heights can be adjusted easily, a floor guide can also be added as an option and a fittings kits can be purchased for where an additional 1 or 2 doors are required.

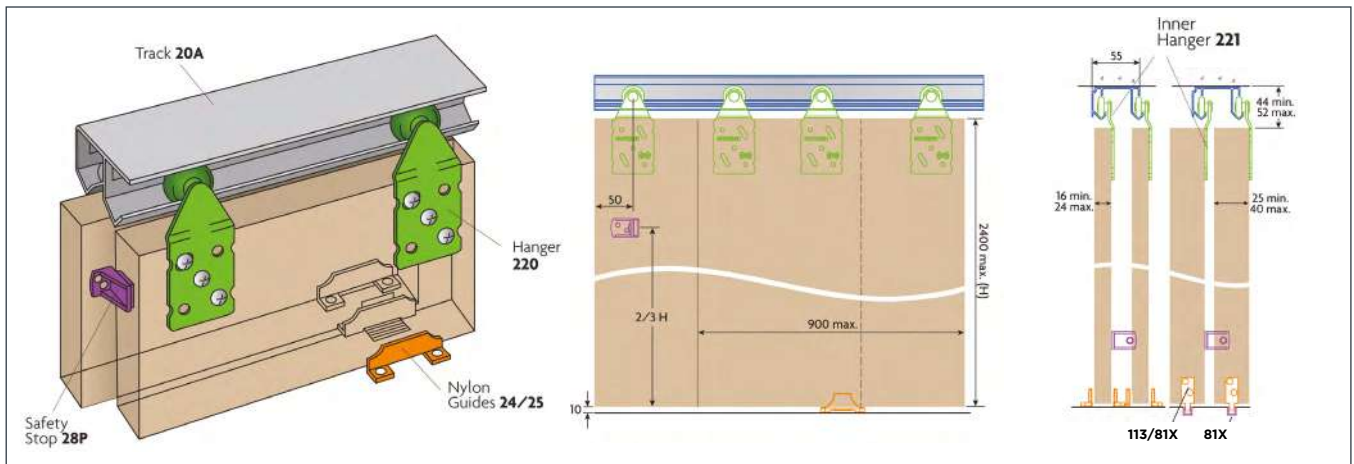

## Product Information

Kit Order Code	No. of Doors	Track Length	Max. Door Height	Max. Door Width	Door Thickness Range	Max. Door Weight
W12	2	1200mm	2400mm	900mm	16 - 40mm	45kg
W15	2	1500mm	2400mm	900mm	16 - 40mm	45kg
W18	2	1800mm	2400mm	900mm	16 - 40mm	45kg
W24	3	2400mm	2400mm	900mm	16 - 40mm	45kg
W01	Fittings Kit to be used when an additional door is required					
W02	Fittings kit to be used when an additional 2 doors are required					

## Kit Contents

Component	Short Code
Aluminium Anti-Rise Soffit Fixing Track (x 1)	20A/****
Outer Offset Hangers (x 2)	220
Inner Offset Hangers (x 2)	221
Reversible Hangers (W24 only) (x 2)	222
Rubber Buffered Stop (x 1 for 2 doors/x 2 for 3 doors)	28P
Nylon Guide (x 1 for 2 door/x 2 for 3 doors)	24/25

\*\*\*\* replace by length of track for full short code

## Accessories



Guide Channel (81X)  
When a guide channel is required



Brushed Aluminium Fascia (F134/\*\*\*\*)  
For doors up to 30mm thick



End Cap Pack for F134 Fascia (F134/ECP)



1 Door Fittings Kit (W01)



Guides for 81X Channel (113/81X)  
2 per door



Brushed Aluminium Fascia (F138/\*\*\*\*)  
for doors up to 25mm thick



End Cap Pack for F138 Fascia (F138/ECP)



2 Door Fittings Kit (W02)

View our full range of door handles and flush pulls on pages 128 and 129.



# MANSION 55

Bottom rolling hardware for internal wooden doors weighing up to 55kg



Mansion 55 is a durable system perfectly suited for high class joinery installations catering for wooden doors weighing up to 55kg each. The product features a concealed bottom roller enabling the weight of the door to be transferred to the floor, making it ideal for when the ceiling or lintel isn't strong enough to support the weight. Please note at least 150mm depth at the bottom of the door must be available to accommodate the concealed bottom rollers when choosing this system.

## Product Information

Product	Max. Door Height	Max. Door Width	Door Thickness Range	Max. Door Weight
Mansion 55	2600mm	1000mm	30 - 57mm	55kg

## Product Specification

Component	Description	Short Code
Top Guide Channel Twice the width of doors	Brass top guide channel available in 1500 and 3000mm lengths	94/****
	Aluminium track available in 1500, 2000, 2500, 3000, 4000, 5000 and 6000mm lengths	94X/****
Guides 2 per door	Galvanised steel guide with brass roller	113R/94
	Concealed nylon guide	106N/94
Bottom Rollers	Nylon wheeled bottom rollers	913N
Bottom Rail	Mill finish aluminium bottom rail available in 1500, 2000, 2500, 3000, 4000 and 6000mm length	915A/****

\*\*\*\* replace by length of track for full short code

SECTION DETAILS

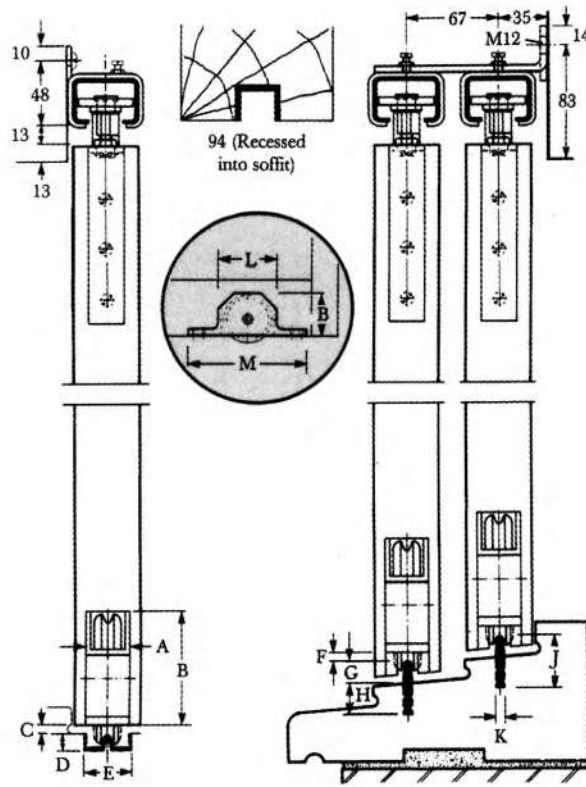

DIMENSIONS

A	B	C	D	E	F	G	H	J	K	L	M
16	37	5	6	21	5	16	16	32	6	48	74

CHOICE OF GEARS

Guide Channels



Bottom Rollers



Bottom Rails



EXAMPLE PLAN DETAILS

Single Run

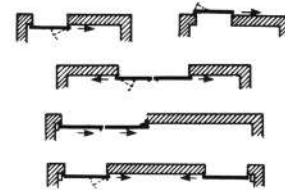

Double Run

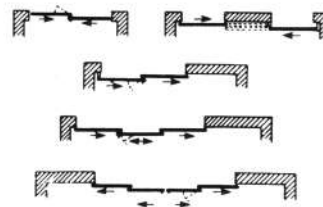

Accessories



Floor Mounted Stop (103)



Double Buffer Wall Mounted Stop (107)  
2 per door

View our full range of door handles and flush pulls on pages 128 and 129.



# POCKET DOOR

Unique sliding door solution that works with cavity walls for doors weighing up to 60kg



Pocket Door is a unique sliding door solution whereby the sliding door disappears into the cavity wall, offering amazing benefits where interior space is limited such as toilets, bathrooms and kitchens. Each Pocket Door kit comes with a pre-assembled aluminium track and header mechanism. For double bi-parting pocket doors, two kits can be used.

## Product Information

Kit Order Code	No. of Doors	Track Length	Max. Door Height	Max. Door Width	Door Thickness Range	Max. Door Weight
PDK3	1	1449mm	1981mm	762mm	28 - 44mm	60kg
PDK4	1	1601mm	1981mm	838mm	28 - 44mm	60kg
PDK5	1	1449mm	2040mm	762mm	28 - 44mm	60kg
PDK6	1	1577mm	2040mm	826mm	28 - 44mm	60kg
PDK10	1	1785mm	2315mm	930mm	28 - 44mm	60kg

## Kit Contents

Component	Short Code
Aluminium Track (x 1)	280M/****
Hangers (x 2)	284
Galvanised Steel Wrapped Softwood Studs (x 4)	-
Galvanised Steel Stud Spacing Brackets (x 2)	-
Galvanised Steel Stud Support Brackets (x 2)	-
Softwood Header Assembly (with pre-fitted track) (x 1)	-
Clip Stop with Adjustable Retention (x 2)	601H
Rubber Buffer (x 1)	287
Flush Pulls (x 2)	385SA

\*\*\*\* replace by length of track for full short code

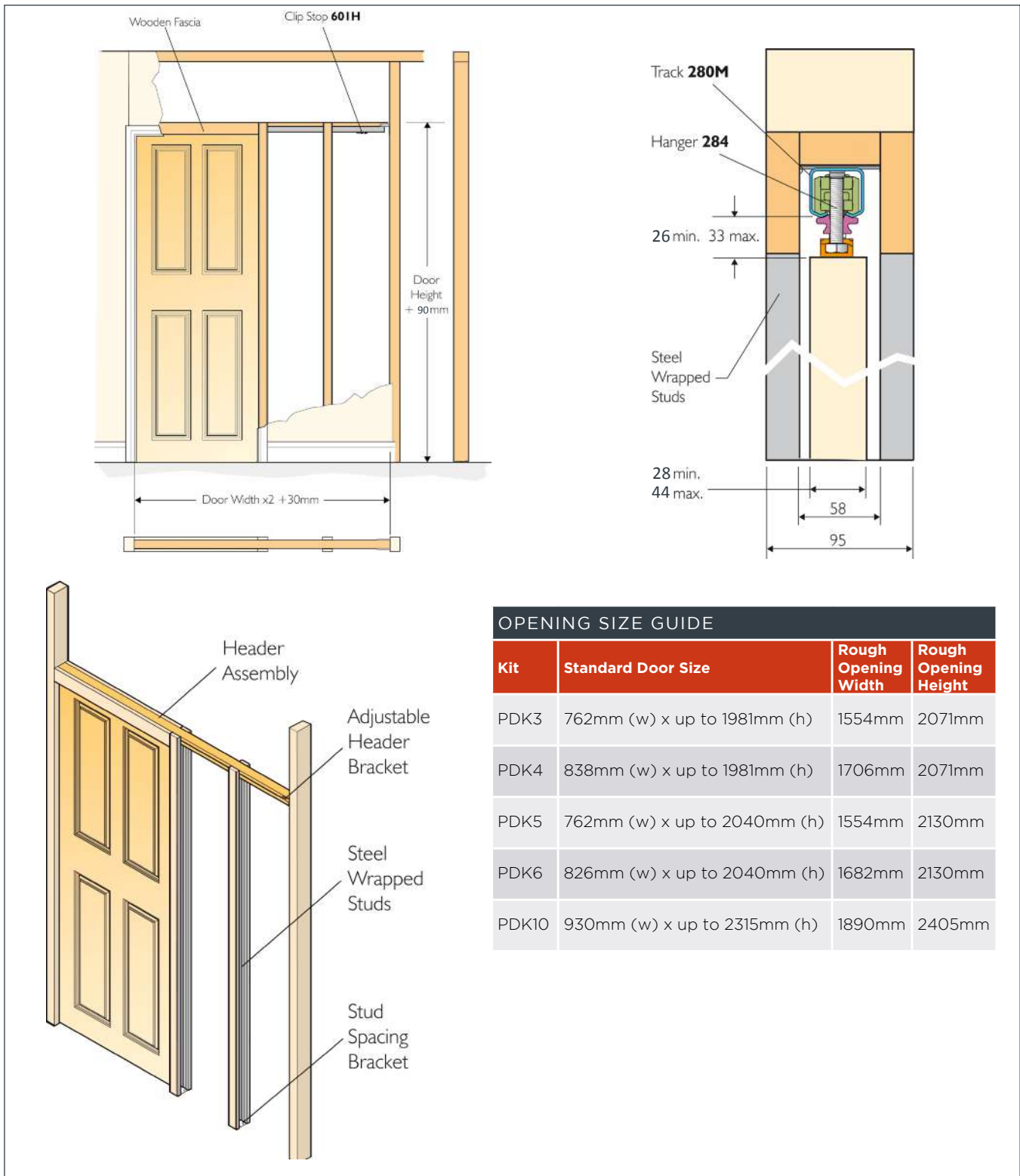

OPENING SIZE GUIDE			
Kit	Standard Door Size	Rough Opening Width	Rough Opening Height
PDK3	762mm (w) x up to 1981mm (h)	1554mm	2071mm
PDK4	838mm (w) x up to 1981mm (h)	1706mm	2071mm
PDK5	762mm (w) x up to 2040mm (h)	1554mm	2130mm
PDK6	826mm (w) x up to 2040mm (h)	1682mm	2130mm
PDK10	930mm (w) x up to 2315mm (h)	1890mm	2405mm

Accessories



Single Soft Stop Kit (**SOFT50**) for doors weighing between 25kg and 50kg



Single Soft Stop Kit (**SOFT100**) for doors weighing between 50kg and 100kg



Satin Lockset (**390SA**) for 30 - 38mm thick doors



Gold Lockset (**390PB**) for 30 - 38mm thick doors



Satin Lockset (**395SA**) for 40 - 48mm thick doors



Gold Lockset (**395PB**) for 40 - 48mm thick doors

Prefer a different style of handle or flush pull to the one provided? View our full range on pages 128 and 129.



# HUSKY GLASS

For sliding glass doors weighing up to 50kg and 75kg



Husky Glass is the ideal solution for lightweight glass applications such as office doors and small domestic glass partitions. Its versatility allows the kit to be face fixed or soffit fixed without compromising on the functionality of the system. The nature of these applications require quality aesthetic finishes and to meet this demand a purpose designed clip on fascia is also available.

## Product Information

Product	Max. Door Height	Max. Door Width	Glass Thickness	Max. Door Weight
Husky Glass	2400mm	1250mm	8, 10 or 12mm	50kg
	2400mm	1250mm	8, 10 or 12mm	75kg

## Product Specification

Component	Description	Short Code
Track	Aluminium track available in 1500, 2000, 2500 and 3000mm lengths	280A/****
	Anodised aluminium track available in 1500, 2000, 2500 and 3000mm lengths	280AN/****
Brackets	Face fixed bracket	281A
	Jointing and end bracket	281AX
Fascia	Aluminium fascia	F136/****
Glass Clamp Kit (50kg) Consists of two hangers, two glass clamps, two 601H retaining stops and an adjustable guide	Glass clamp kit for 8mm glass	8/HY/50
	Glass clamp kit for 10mm glass	10/HY/50
	Glass clamp kit for 12mm glass	12/HY/50
Glass Clamp Kit (75kg) Consists of two hangers, two glass clamps, two 601H retaining stops and an adjustable guide	Glass clamp kit for 8mm glass	8/HY/75
	Glass clamp kit for 10mm glass	10/HY/75
	Glass clamp kit for 12mm glass	12/HY/75
Floor Guide	Brushed stainless steel floor guide for 8mm, 10mm or 12mm glass	8-12/SN

\*\*\*\* replace by length of track for full short code



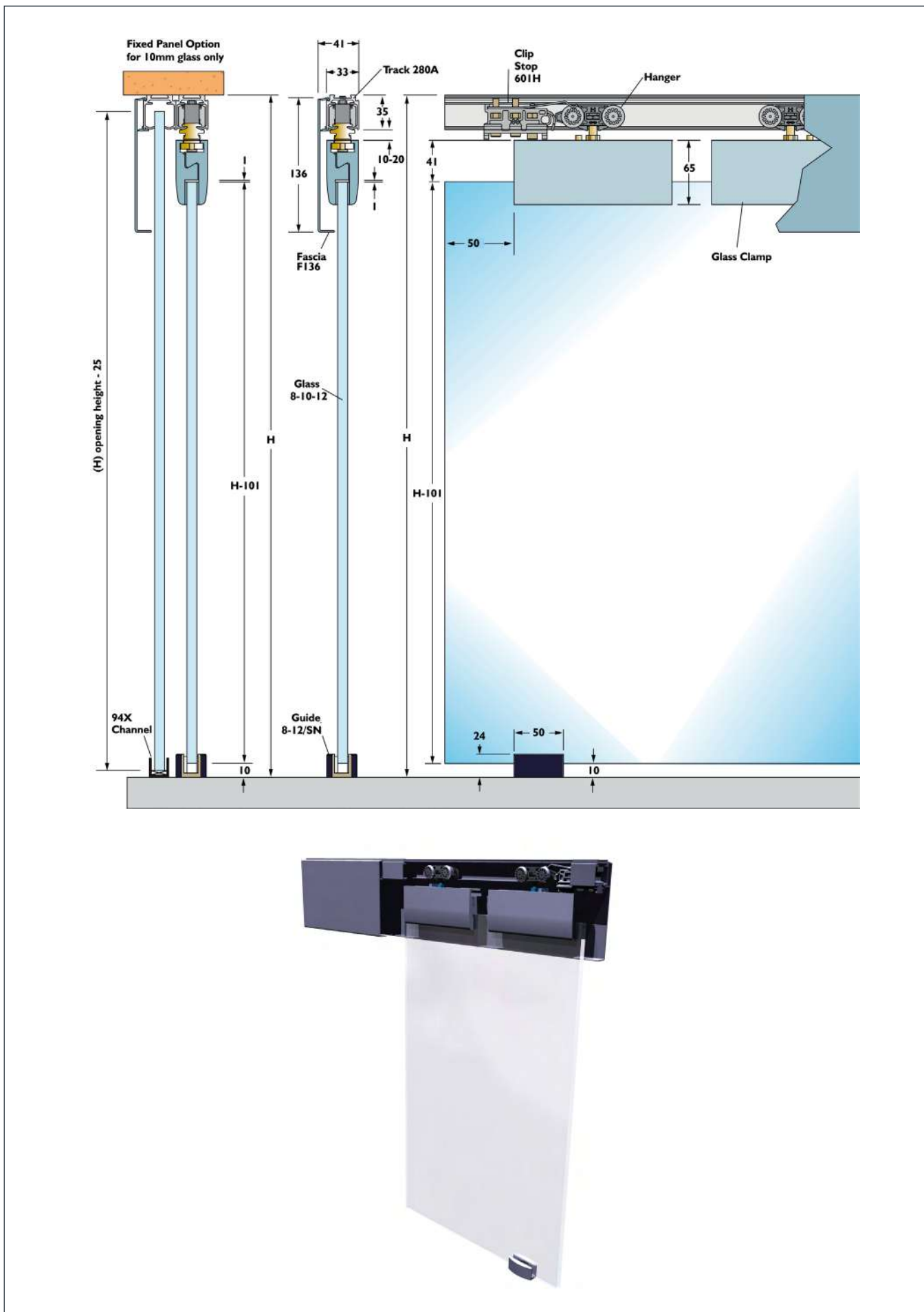

Accessories [View our full range of door handles and flush pulls on pages 128 and 129.](#)

# HUSKY TELESCOPIC

For sliding wooden telescopic doors weighing up to 80kg

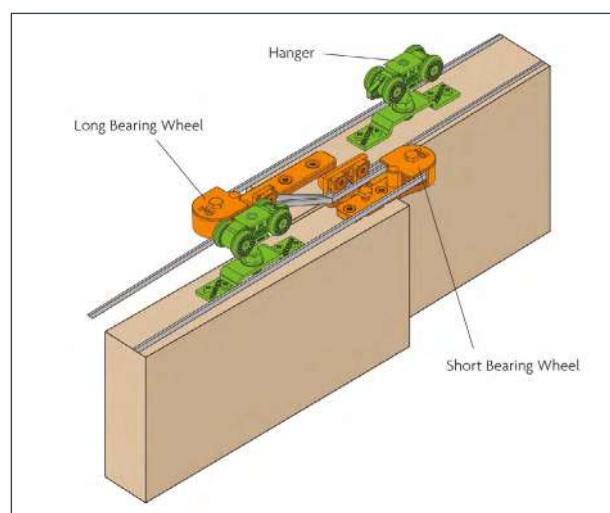

For a natural, modern or period look, the Husky Telescopic range allows multiple wooden doors weighing up to 80kg each to become easily stacked sliding partitions. The system has been designed to be discreet as it requires no guide channel meaning that there are no dust traps and therefore easier to install across a variety of applications. All doors are linked together via a toothed belt and pulley system. By moving the lead door, all of the doors travel simultaneously with minimum friction and noise. The system is suitable for wood framed doors of flush, panelled or glazed construction and makes for an ideal room divider or partition door.

## Product Information

Kit Order Code	No. of Doors	Max. Door Height	Min. Door Width	Max. Door Width	Door Thickness Range	Max. Door Weight
TEL80/2	2	2700mm	500mm	1200mm	32 - 47mm	80kg
TEL80/3	3	2700mm	500mm	1200mm	32 - 47mm	80kg
TEL80/SIM	4 (2 to either side)	2700mm	500mm	1200mm	32 - 47mm	80kg

## Kit Contents

Component	TEL80/2 Quantity	TEL80/3 Quantity	TEL80/SIM Quantity
Husky Hangers and Apron Plates	4	6	8
Short Bearing Wheel Assembly	1	2	2
Door Mounted Belt Fixing Bracket	1	2	4
Length of Toothed Belt	1	1	1
Following Door Guide	1	2	2
Fixed Base Floor Guide	1	1	2
Long Bearing Wheel Assembly	1	2	2
Wall Mounted Belt Fixing	1	1	2

## Track Specification - track must be purchased in addition to kit

Description	Short Code
Aluminium track in 1500, 2000, 2500, 3000, 4000, 5000 and 6000mm lengths	280A/****
Anodised aluminium track in 1500, 2000, 2500, 3000, 4000, 5000 and 6000mm lengths.	280AN/****

\*\*\*\* replace by length of track for full short code

## Accessories



Aluminium Face Fixed Brackets x 5 (**2815A**)



Aluminium Face Fixed Brackets x 8 (**2818A**)

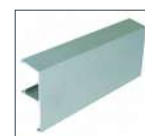

Soffit Fixed Fascia (**F134**) for aluminium track for doors up to 50mm thick



Face Fixed Fascia (**F140**) for aluminium track for doors up to 50mm thick

**View our full range of door handles and flush pulls on pages 128 and 129.**

# SIROCCO

Self-closing system for wooden or metal sliding doors weighing up to 80kg



The Sirocco system is a quiet, user friendly system with an integrated hydraulic soft stop which brings the door to a safe and cushioned close. The system has been designed to give a quiet and smooth operation and features an adjustable closing speed feature offering all the benefits of an automatic door without the need for a power source. Common applications for this system include hospitals and disabled access points, the optional hold open unit also allows you to adjust the time before the soft close engages meaning you can hold the door open for as long as required.

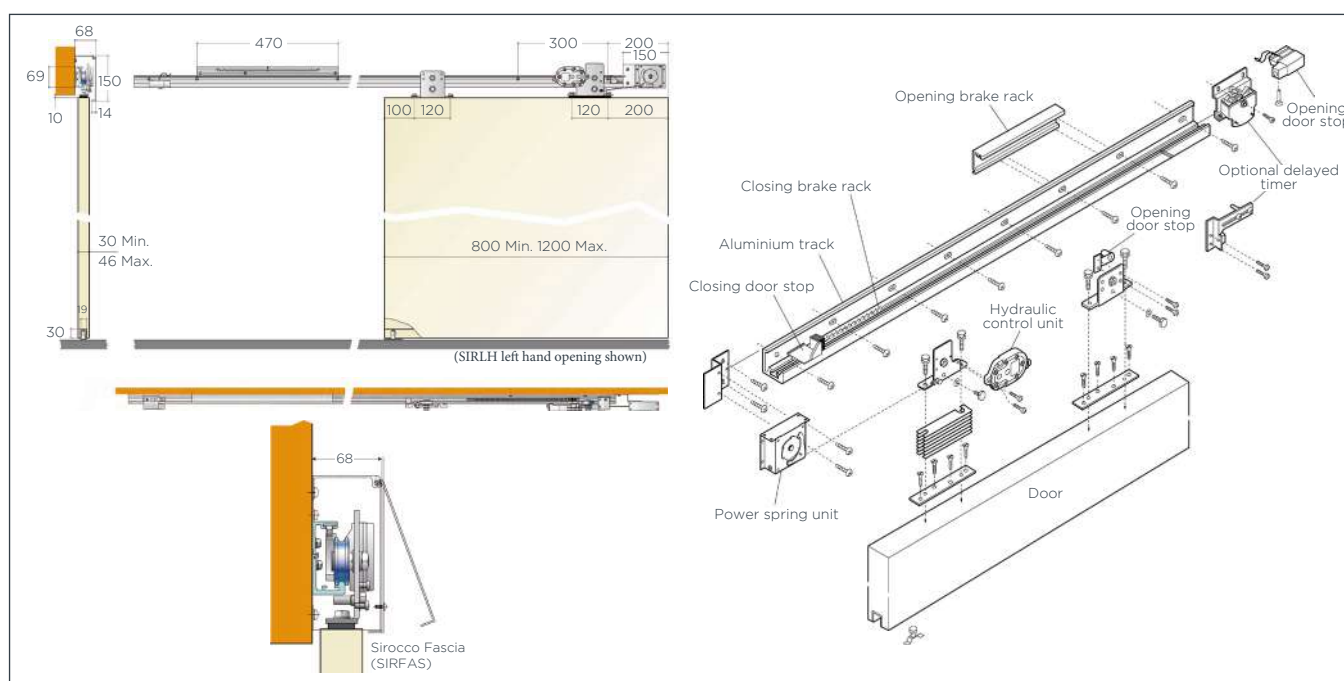

## Product Information

Kit Order Code	Description	No. of Doors	Track Length	Max. Door Height	Max. Door Width	Door Thickness Range	Max. Door Weight
SIRRH	Right hand opening kit	1	2200mm	3000mm	1200mm	30 - 46mm	80kg
SIRLH	Left hand opening kit	1	2200mm	3000mm	1200mm	30 - 46mm	80kg

## Accessories



Delayed Closing Timer Right Hand (**DELRH\***)



Delayed Closing Timer Left Hand (**DELLH**)



Fascia (**SIRFAS**)

**View our full range of door handles and flush pulls on pages 128 and 129.**

Main image shows SIRRH - right hand opening kit



# RUSTIC 80

Unique sliding door hardware with beautifully crafted barn style hangers, for doors weighing up to 80kg



Rustic 80 is ideal for barn conversions, period properties or simply for a unique feature in the home. Suitable for internal doors weighing up to 80kg, the system creates a traditional look for sliding wooden or metal doors with the exposed steel straps fastening down the front of the door to support the rustic finish. The beautifully crafted barn door style hangers run smoothly across the flat bar track. The system is available in two track lengths and in a black matt powder coat or stainless steel finish. A soft stop kit is available to create a soft opening or close, as well as a fittings kit for when an additional door is required.



## Product Information

Kit Order Code	Finish	No. of Doors	Track Length	Max. Door Height	Door Width Range	Door Thickness Range	Max. Door Weight
R80/20	Black	1	2000mm	3000mm	500 - 1000mm	36 - 46mm	80kg
R80/30	Black	1	3000mm	3000mm	500 - 1000mm	36 - 46mm	80kg
R80SS/20	Stainless Steel	1	2000mm	3000mm	500 - 1000mm	36 - 46mm	80kg
R80SS/30	Stainless Steel	1	3000mm	3000mm	500 - 1000mm	36 - 46mm	80kg
R80	Black	Fittings Kit to be used when an additional door is required					
R80SS	Stainless Steel	Fittings Kit to be used when an additional door is required					

## Kit Contents

### Component

- Hangers (x 2)
- Door Stops (x 2)
- Floor Guide (x 1)
- "Flat" Track (x 1)
- Track Wall Spacers (x 5 for 2m, x 7 for 3m)
- Anti-Jump Camp (x 2)
- Oval Flush Pulls (x 2) (144B or 144S)



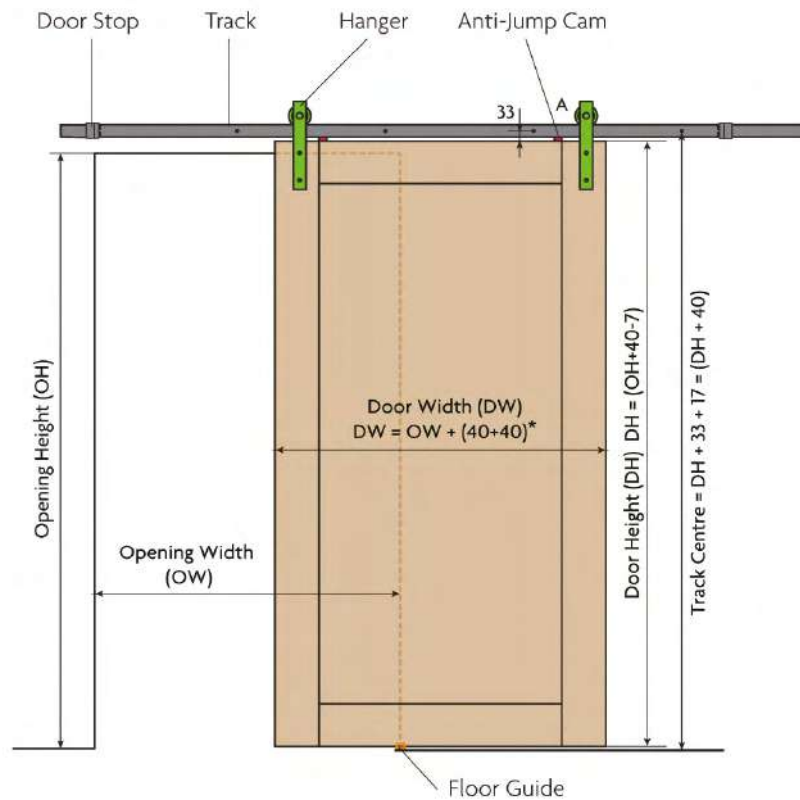

\* PCH Suggests 40mm overlap of the door to the opening

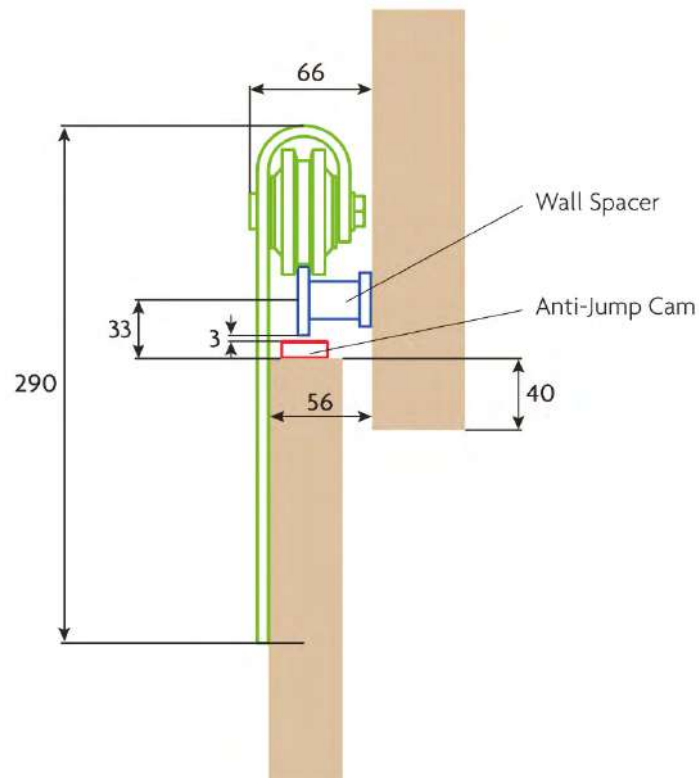

## Accessories



1 Door Fittings Kit in Black (R80)



1 Door Fittings Kit in Stainless Steel (R80SS)



Rustic Soft Stop Kit (R80SOFT)

**Prefer a different style of flush pull or handle to the one provided? View our full range on pages 128 and 129.**



# VELARO

For sliding glass doors weighing up to 80kg each



Designed and tested for interior applications, Velaro features a concealed, smooth and quiet operating system thanks to its purpose built polymer rollers and brush strip within the track. Ideal for soffit fixed and face fixed installations, this single door system incorporates a stylish design with unrivalled performance to create a modern and minimalistic finish, with all parts concealed within the track.

The system is available as a regular sliding system or with the inclusion of a single or double soft stop damper which gently decelerates the sliding glass doors and pulls them into position for the final 110mm of travel. The system caters for 8mm, 10mm or 12mm thick glass panels.

## Product Information

Product	Max. Door Height	Max. Door Width	Glass Thickness	Max. Door Weight
Velaro	2500mm	1200mm	8, 10 or 12mm	80kg
Velaro With Single Soft Stop	2500mm	1200mm	8, 10 or 12mm	80kg
Velaro with Double Soft Stop	2500mm	1200mm	8, 10 or 12mm	80kg

## Product Specification

Component	Description	Short Code
Track Complete with brush strips and end caps	Anodised aluminium soffit fixed track available in 2000, 2500, 3000, 3500, 4000, 5000 and 6000mm lengths	V80SF/****
	Anodised aluminium face fixed track available in 2000, 2500, 3000, 4000, 5000 and 6000mm lengths	V80FF/****
	Anodised aluminium fixed panel track available in 2000, 2500, 3000, 4000, 5000 and 6000mm lengths	V80FP/****
Glass Clamp Kit Consists of two clamps complete with gaskets, two clip stops and one brushed stainless steel adjustable floor guide	Glass clamp kit for 8mm glass	V80/8
	Glass clamp kit for 10mm glass	V80/10
	Glass clamp kit for 12mm glass	V80/12
Glass Clamp Kit With Single Soft Stop Consists of two clamps complete with gaskets, left hand and right hand wheel carriage, single damper assembly, activation bracket, end stop block and floor guide.	Glass clamp kit for 8mm glass with single soft stop damper	VS80/8
	Glass clamp kit for 10mm glass with single soft stop damper	VS80/10
	Glass clamp kit for 12mm glass with single soft stop damper	VS80/12
Glass Clamp Kit With Double Soft Stop Consists of two glass clamps with gaskets, left hand and right hand wheel carriage, double damper assembly, activation bracket, end stop block and floor guide.	Glass clamp kit for 8mm glass with double soft stop damper	VD80/8
	Glass clamp kit for 10mm glass with double soft stop damper	VD80/10
	Glass clamp kit for 12mm glass with double soft stop damper	VD80/12

\*\*\*\* replace by length of track for full short code

## Accessories



Floor Channel  
(94X/\*\*\*\*)  
for fixed panel  
option

**View our full range of door handles and flush pulls on pages 128 and 129.**

# MARATHON

For sliding wooden and metal doors weighing up to 55kg and 90kg



When it comes to residential or commercial sliding doors and partitions, Marathon sliding door hardware is in a class of its own. Designed for wooden, wood framed and composite doors and featuring a one piece ball cage design, Marathon offers a smooth running system which can easily be adjusted. A fire door kit and self closing door kit can also be added to further complement the system (see accessories).

Available as the Marathon 55 for doors up to 55kg and Marathon 90 for doors up to 90kg, it can handle door thicknesses of between 35 - 50mm and door widths of up to 2500mm.

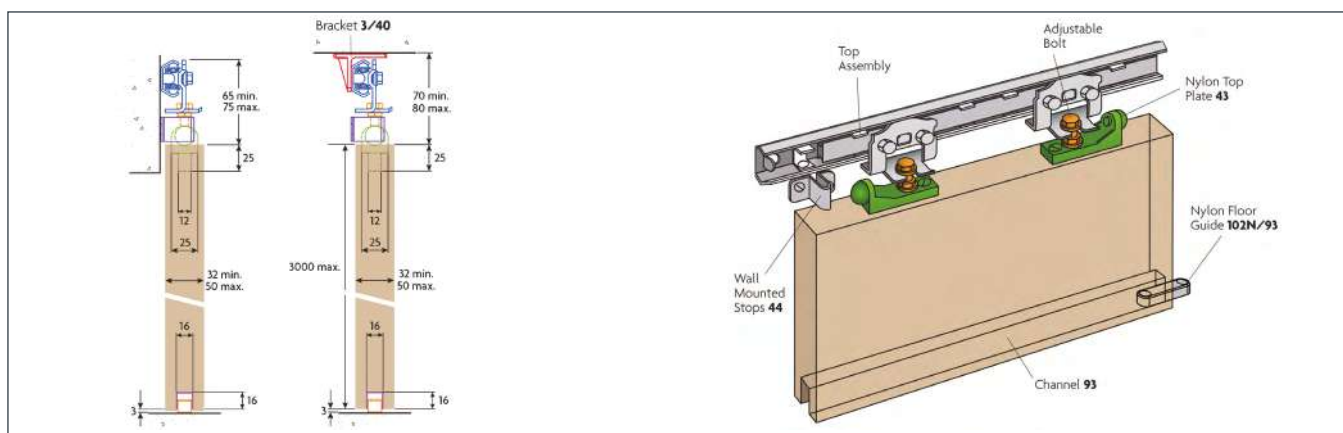

## Product Information

Product	Kit Order Code	No. of Doors	Track Length	Max. Door Height	Door Width Range	Door Thickness Range	Max. Door Weight
Marathon 55	J2	1	1219mm	3000mm	400 - 750mm	32 - 50mm	55kg
	J3	1	1473mm	3000mm	750 - 900mm	32 - 50mm	55kg
	J4	1	1702mm	3000mm	900 - 1050mm	32 - 50mm	55kg
	J5	1	1981mm	3000mm	1050 - 1200mm	32 - 50mm	55kg
	J6	1	2438mm	3000mm	1200 - 1500mm	32 - 50mm	55kg
Marathon 90	S2	1	1219mm	3000mm	400 - 750mm	32 - 50mm	90kg
	S3	1	1473mm	3000mm	750 - 900mm	32 - 50mm	90kg
	S4	1	1702mm	3000mm	900 - 1050mm	32 - 50mm	90kg
	S5	1	1981mm	3000mm	1050 - 1200mm	32 - 50mm	90kg
	S6	1	2438mm	3000mm	1200 - 1500mm	32 - 50mm	90kg
	S7	1	3048mm	3000mm	1500 - 1800mm	32 - 50mm	90kg
	S8	1	3226mm	3000mm	1800 - 2000mm	32 - 50mm	90kg
S9	1	4420mm	3000mm	2000 - 2500mm	32 - 50mm	90kg	

## Kit Contents

Component	Short Code
Top Assembly (x 1)	-
Nylon Top Plates (x 2)	43
Wall Mounted Stops (x 2)	44
Nylon Floor Guide Channel (x 1*)	102N/93
Guide Channel (x 1)	93/****

\*\*\*\* Replace with door width for full short code

\*2 Guides are supplied in the J6, S6, S7, S8 and S9 kits

\*\* Only available for S3, S4, S5 and S6

## Accessories



Self-Closing Door Kit (**SCK1**)



Self-Closing Fire Door Kit (**FDK1**\*\*)



Non Self-Closing Fire Door Kit (**FDK2**\*\*)



Easyclose Automatic Door Closer (**SC100**)



Galvanised Steel Fascia (**40P/1850**)



Fascia End Cap (**EC40P**)



Soffit Fixed Brackets x 5 (**3/40**)

**View our full range of door handles and flush pulls on pages 128 and 129.**





# HUSKY SLIDING

For sliding wooden doors weighing up to 50kg and 100kg



Versatile and quiet, the Husky sliding door hardware system is ideal for creating wardrobe doors and room dividing doors with one or more wooden, wood framed, composite or metal doors at each side. The Husky 50 supports doors of up to 50kg, whilst the Husky 100 supports slightly heavier doors up to 100kg. Optional fittings kits allow additional doors to be fitted to a maximum door width of 1250mm as well as a soft stop kit available for enhanced operation. The product comes available with a choice of a galvanised steel, aluminium or anodised aluminium track.

## Product Information

Product	Kit Order Code (Steel Track)	Kit Order Code (Aluminium Track*)	No. of Doors	Track Length	Max. Door Height	Max. Door Width	Door Thickness Range	Max. Door Weight
Husky 50	H50/15	H50/15A	1	1500mm	2700mm	800mm	20 - 50mm	50kg
	H50/18	H50/18A	1	1800mm	2700mm	950mm	20 - 50mm	50kg
	H50/20	H50/20A	1	2000mm	2700mm	1050mm	20 - 50mm	50kg
	H50/24	H50/24A	1	2400mm	2700mm	1250mm	20 - 50mm	50kg
	H50N		Fittings Kit for where an additional door is required					
Husky 100	H100/15	H100/15A	1	1500mm	2700mm	800mm	20 - 50mm	100kg
	H100/18	H100/18A	1	1800mm	2700mm	950mm	20 - 50mm	100kg
	H100/20	H100/20A	1	2000mm	2700mm	1050mm	20 - 50mm	100kg
	H100/24	H100/24A	1	2400mm	2700mm	1250mm	20 - 50mm	100kg
	H100		Fittings Kit for where an additional door is required					

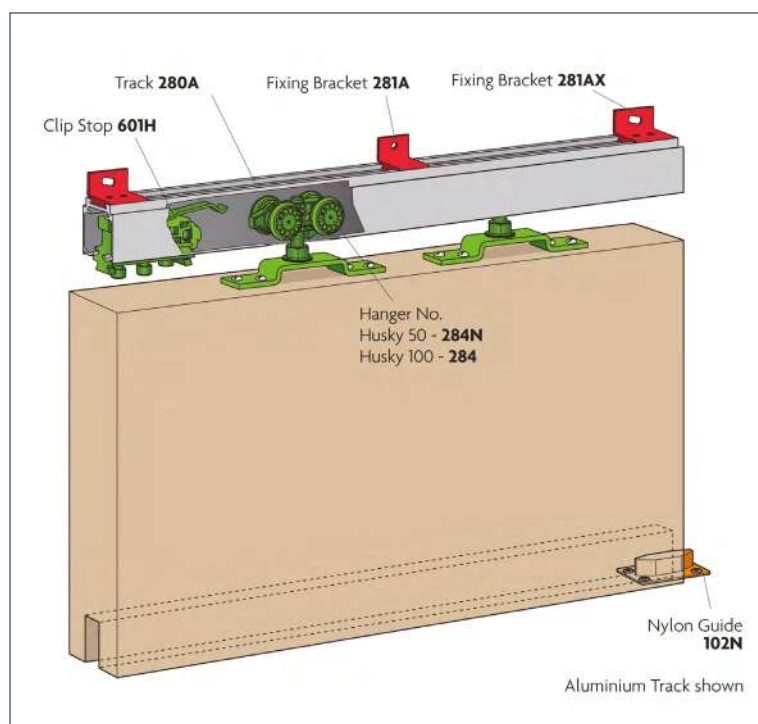

## Kit Contents

Component	Short Code (Aluminium)*	Short Code (Steel)
Track (x 1)*	280A/****	280/****
Face Fixed Brackets	281A	281
Nylon Bodied Hangers (x 2)	284 or 284N**	284 or 284N**
Nylon Guide (x 1)	102N	102N
Clip Stop (x 1)	601H	601H
Track Stop (x 1)	287	287

\*An anodised aluminium track (280AN/\*\*\*\*) is also available.  
 \*\*Use 284N for Husky 50 and 284 for Husky 100. For metal doors, hangers 285 or 285N are required.  
 \*\*\*\*replace by length of track for full short code

Product can be specified as individual components to suit specific project requirements

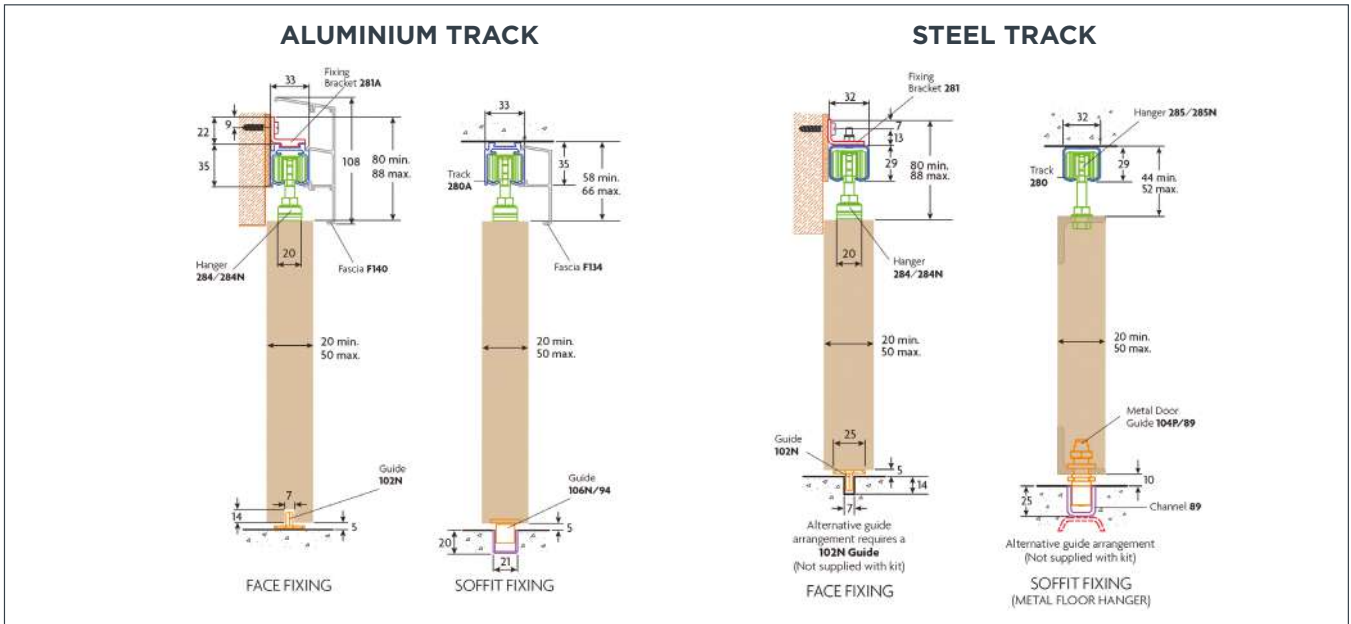

Accessories

Soft Stop, Low Headroom and Simultaneous Action Kits



Low Headroom Kit (LH100)



Simultaneous Action Kit (SIM100)



Single or Double Soft Stop (SOFT50 or SOFT50D)\* for doors weighing between 25kg and 50kg



Single or Double Soft Stop (SOFT100 or SOFT100X2)\* for doors weighing between 50kg and 100kg



Easyclose Automatic Door Closer (SC100) for doors weighing up to 100kg

Fittings Kits



1 Door Fittings Kit for Husky 50 (H50N)



1 Door Fittings Kit for Husky 100 (H100)

Fascia



Aluminium Soffit Fixed Fascia (F138/\*\*\*\*) for doors up to 25mm thick



F138 Fascia Endcap Pack (F138/ECP)



Aluminium Soffit Fixed Fascia (F134/\*\*\*\*) for doors up to 50mm thick



F134 Fascia Endcap Pack (F134/ECP)



Aluminium Face Fixed Fascia (F140/\*\*\*\*) for doors up to 50mm thick including end caps



F140 Fascia End Cap Pack (F140/ECP)

\*Only for use with Husky 100

Alternative Guiding System



Aluminium Guide Channel (94X)



Roller Guide for Wooden Doors (106N/94)



Roller Guide for Metal Doors (104P/89)

Door stops



Floor Stop (103)

Brackets



Face Fixed Brackets - pack of 5 (2815) for steel track



Face Fixed Brackets - pack of 8 (2818) for steel track



Face Fixed Brackets - Pack of 5 (2815A) for aluminium track



Face Fixed Brackets - pack of 8 (2818A) for aluminium track

View our full range of door handles and flush pulls on pages 128 and 129.



# UNIVERSAL TELESCOPIC

For sliding telescopic wooden doors weighing up to 80kg and 120kg

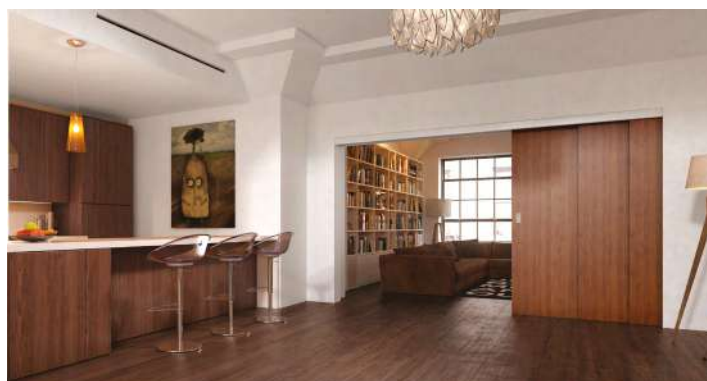

Universal Telescopic works alongside the Husky 100 and Soltaire 120 systems for top hung wooden doors weighing up to 80kg or 120kg. The Telescopic systems allow all the doors to be linked together using a toothed belt and pulley system so that they move in a simultaneous action. The system also incorporates the coveted ghost guide which keeps the area clean and free from trip hazards. In addition to this, the door panels can be neatly stacked into the wall cavity to allow for flexible open plan living.

## Product Information

Kit Order Code	Used With	No. of Doors	Max. Door Height	Max. Door Width	Min. Door Width	Door Thickness Range (Husky)	Max. Door Weight
UTEL2	Husky 100	2	2700mm	1200mm	500mm	32 - 47mm	80kg
	Soltaire 120	2	2700mm	1200mm	500mm	35 - 47mm	120kg
UTEL3	Husky 100	3	2700mm	1200mm	500mm	32 - 47mm	80kg
	Soltaire 120	3	2700mm	1200mm	500mm	35 - 47mm	120kg
UTEL4	Husky 100	4 (2+2)	2700mm	1200mm	500mm	32 - 47mm	80kg
	Soltaire 120	4 (2+2)	2700mm	1200mm	500mm	35 - 47mm	120kg

## Kit Contents

Component	UTEL 2 Quantity	UTEL 3 Quantity	UTEL 4 Quantity
Short Bearing Wheel Assembly	1	2	2
Door Mounted Belt Fixing Bracket	1	2	4
Length of Toothed Belt	1	1	1
Following Door Guide	1	2	2
Fixed Base Floor Guide	1	1	2
Long Bearing Wheel Assembly	1	2	2
Wall Mounted Belt Fixing	1	1	2

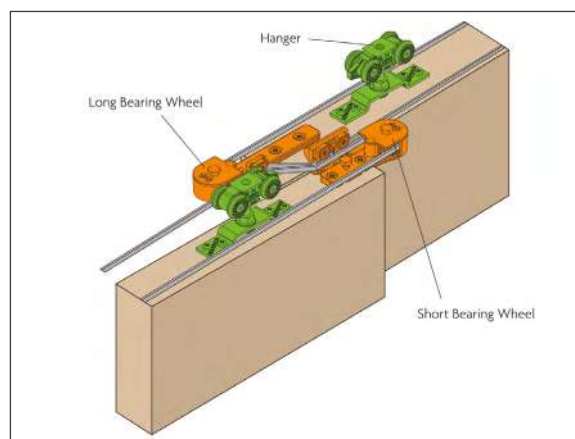

## Hangers, Track Stops and Track Specification - Must be purchased in addition to kit

Accompanying Product	Component	Description	Short Code
Husky 100	Track	Aluminium mill finish track available in 2000, 2500, 3000, 4000, 5000 and 6000mm lengths	280A/****
		Anodised aluminium track available in 2000, 2500, 3000, 4000, 5000 and 6000mm lengths	280AN/****
	Hanger 2 per door	For wooden doors	284
	Track Stops 2 per system	Track Stop	287
Clip Stop		601H	
Soltaire 120	Track	Anodised aluminium track available in 2000, 2500, 3000, 4000, 5000 and 6000mm lengths.	120/****
	Hanger 2 per door	Hanger with surface mounted apron plate	51/120/SS
	Track Stops 2 per system	Track Stop	HH4/SS

\*\*\*\* replace by length of track for full short code

## Accessories

[View our full range of door handles and flush pulls on pages 128 and 129.](#)

# SIENNA

Elegant system for sliding, frameless wooden doors weighing up to 120kg



Sienna is an elegant sliding system that creates a minimalistic and stylish look. It is designed to accommodate wooden doors of 30 - 70mm thickness and a weight capacity of 120kg. The systems rollers are expertly engineered to effortlessly run along the brushed stainless steel tubular track and stops are positioned on the track to limit the amount of door travel.

## Product Information

Kit Order Code	No. of Doors	Min. Door Width	Max. Door Width	Door Thickness Range	Max. Door Weight
SN120T	1	700mm	2500mm	30 - 70mm	120kg

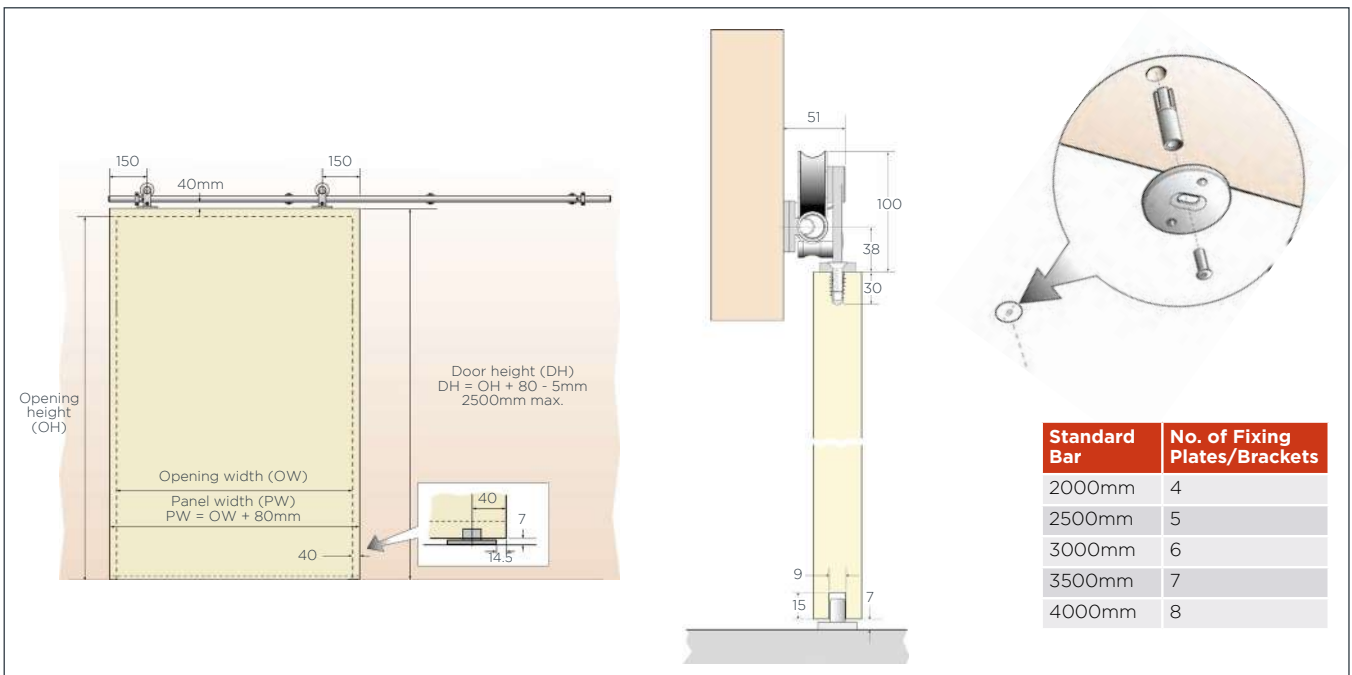

Track Specification - Must be purchased in addition to kit

Description	Short Code
25mm stainless steel tubular track available in 2000, 2500, 3000, 3500, 4000 and 6000mm length. Comes complete with correct number of brackets.	25/****T

\*\*\* Replace with door width for full short code

## Kit Contents

Component	Short Code
Hangers (x 2)	-
Door Stops (x 2)	25/UDS
Guide (x 1)	101SS
Bar End Caps (x 2)	25/EC

## Accessories



End Sleeve  
for Sienna Bar  
(25/SS)

**View our full range of door handles and flush pulls on pages 128 and 129.**



# SIENNA GLASS

Stainless steel sliding bar system for glass doors weighing up to 120kg



This elegant frameless system creates a minimalistic look thanks to the modern design of the stainless steel hangers. Specialised rollers have been engineered to effortlessly run along a brushed stainless steel tubular track, enabling this system to be one of the most efficient on the market.

The system has been designed for use with applications requiring glass door to glass wall or glass door to solid wall fixings. Stops positioned on the track limit the door travel.

For bracket spacing calculations, please see the product datasheet which can be downloaded from our website.

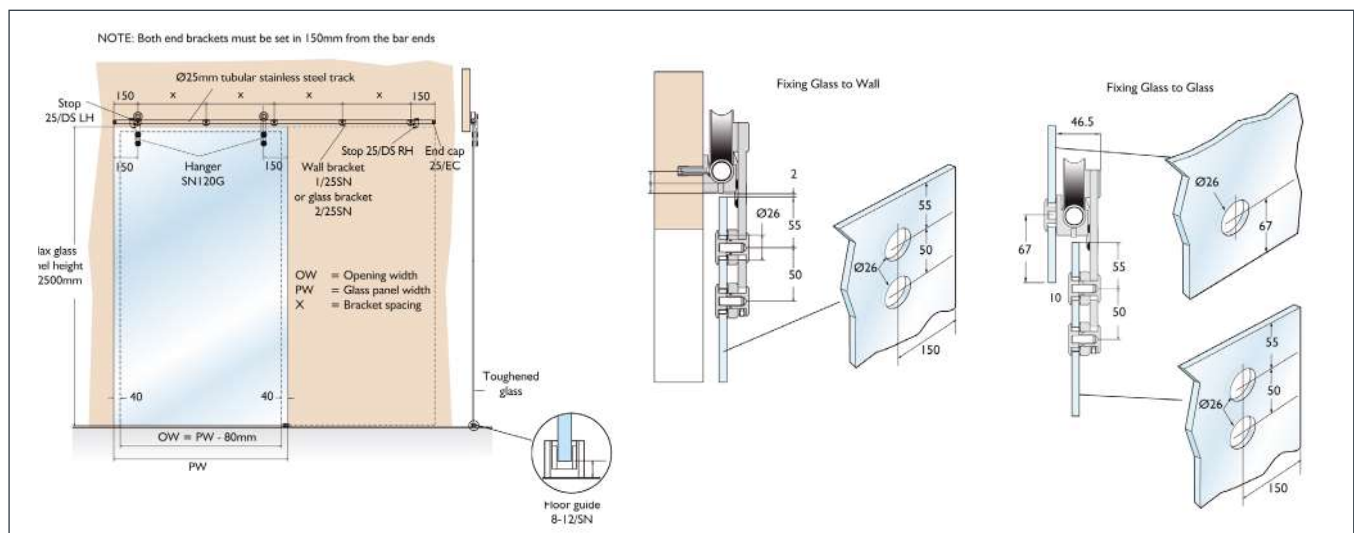

## Product Information

Kit Order Code	No. of Doors	Max. Door Height	Max. Door Width	Glass Thickness	Max. Door Weight
SN120G	1	2500mm	1400mm	8, 10 or 12mm	120kg

## Track and Bracket Specification - Must be purchased in addition to kit

Component	Description	Short Code
Track	25mm stainless steel tubular track available in 2000, 2500, 3000, 3500, 4000 and 6000mm lengths	25/****
Brackets	Face fixed bracket for solid wall	1/25SN
	Face fixed bracket for glass wall	2/25SN

## Kit Contents

Component	Short Code
Hangers (x 2)	-
Door Stops (x 2)	25/DSR or 25/DSL
Guide (x 1)	**/SN
Bar End Caps (x 2)	25/EC
Fitting Tool (x1)	25/TOOL

## Accessories



End Sleeve  
for Sienna Bar  
(25/SS)

**View our full  
range of door  
handles and flush  
pulls on pages  
128 and 129.**

# PACER GLASS

For sliding glass doors weighing up to 130kg and 180kg



Pacer Glass is a sophisticated system which accommodates both sliding and fixed glass panels, making it ideal for interior dividers in offices and shops as well as more modern applications in new developments. The nature of these applications require quality aesthetic finishes and, to meet this demand, Pacer has an additional purpose designed clip on fascia for both soffit fixed and face fixed applications.



## Product Information

Product	Max. Door Height	Max. Door Width	Glass Thickness	Max. Door Weight
Pacer Glass	3000mm	3000mm	8, 10 or 12mm	130kg
	3000mm	3000mm	8, 10 or 12mm	180kg

## Product Specification

Component	Description	Short Code
Track	Anodised aluminium track in 2000, 2500, 3000, 3500, 4000 and 6000mm lengths	600/****AN
	Aluminium mill finish track in 2000, 2500, 3000, 3500, 4000 and 6000mm lengths	600/****
Fixed Glass Panel Bracket	Bracket for fixed glass panel	600FPB
Brackets	Face fixed bracket	1B
	Joining bracket	1BX
Glass Clamp Kit (130kg) Consists of two 56 hanger assemblies, two glass clamp assemblies, a universal guide and two 601P retaining stops	Glass clamp kit for 8mm glass	8/PA/130
	Glass clamp kit for 10mm glass	10/PA/130
	Glass clamp kit for 12mm glass	12/PA/130
Glass Clamp Kit (180kg) Consists of two 56 hanger assemblies, two glass clamp assemblies, a universal guide and two 601P retaining stops	Glass clamp kit for 8mm glass	8/PA/180
	Glass clamp kit for 10mm glass	10/PA/180
	Glass clamp kit for 12mm glass	12/PA/180
Floor Guide	Floor guide for 8, 10 or 12mm glass	8-12/SN
Fascia	Fascia for soffit fixed track	F160X/****
	Fascia for face fixed track	F200/****

\*\*\*\* replace by length of track for full short code

Accessories

[View our full range of door handles and flush pulls on pages 128 and 129.](#)

# PACER GLASS CONTINUED

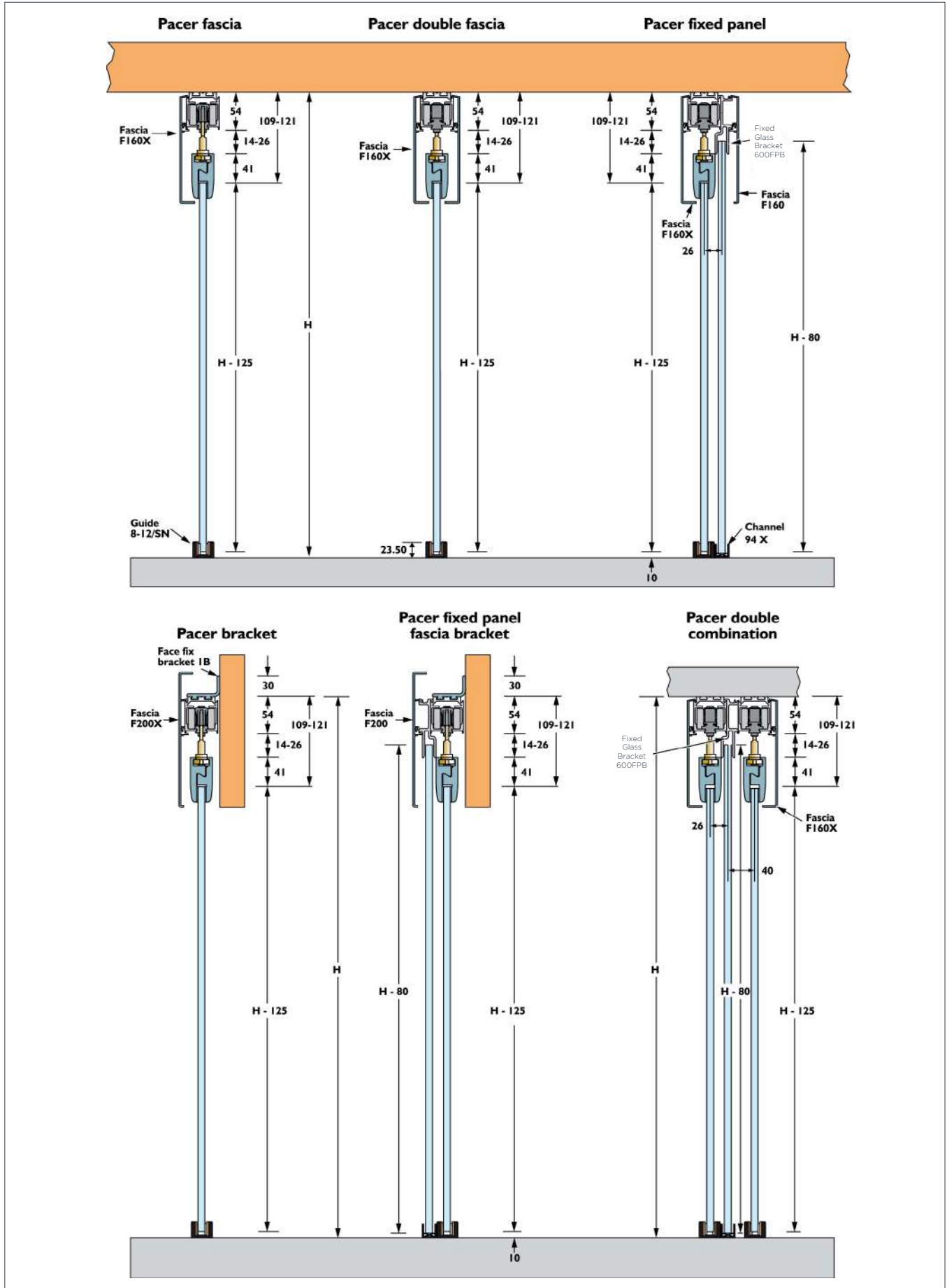

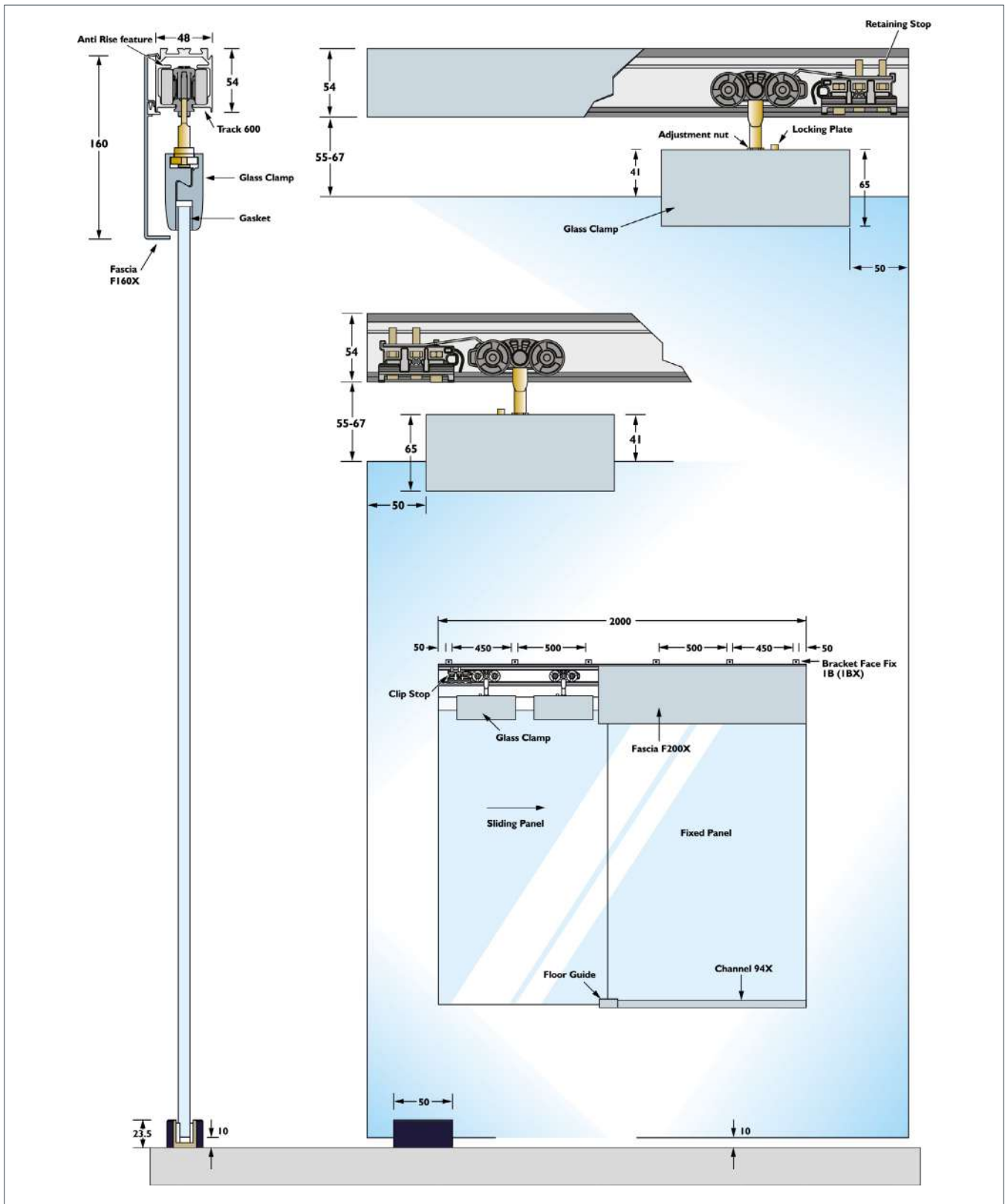

Accessories



F160 Fascia End Cap Pack (F160/ECP)



F200 Fascia End Cap Pack (F200/ECP)

View our full range of door handles and flush pulls on pages 128 and 129.



# PACER SLIDING

For wooden and metal sliding doors weighing up to 200kg



Combining performance and style Pacer Sliding is suitable for wooden, aluminium or metal doors weighing up to 200kg. The system is ideally suited to modern applications including offices, shop fronts and other stylish interiors. Various guide channels are available including brass, aluminium and an aluminium threshold. A track mounted aluminium fascia is also available for face fixed and soffit fixed applications to conceal the working components. Wooden doors may be either solid or glazed and metal doors can be angle or box section.



## Product Information

Product	Max. Door Height	Max. Door Width	Door Thickness Range	Max. Door Weight
Pacer Sliding	3000mm	2000mm	35 – 46mm	200kg

## Product Specification

Component	Description	Short Code
Track	Aluminium mill finish track in 2000, 3000, 4000 and 6000mm lengths	600/****
	Aluminium anodised finish track in 2000, 3000, 4000 and 6000mm lengths	600/****AN
Brackets	Face fixed bracket	1B
	Jointing bracket	1BX
Hangers	Angle plate fixing hanger for wooden doors	52B
	Hanger for angle frame metal doors	56B
	Hanger for box frame metal doors	56BX
	Concealed fixing hanger for wooden doors, aluminium doors or metal doors	57B
Guides	Floor mounted guide for wooden, aluminium or metal doors	89/2N
	Concealed fixing guide for wooden or aluminium doors	106N/94
	Guide for angle frame metal doors	104N/94
	Guide for box frame metal doors	104NX/94
Guide Channel	Brass guide channel available in 1500 and 3000mm lengths	94/****
	Aluminium guide channel available in 1500, 2000, 2500, 3000, 4000 and 6000mm lengths.	94X/****
	Aluminium threshold in 2000, 2500, 3000, 3500, 4000 and 6000mm lengths.	94T/****
	Polypropylene channel in black, available in 2000, 2500, 3000, 3500, 4000, 5000 and 6000mm lengths	94P/****
Fascia	Satin anodised aluminium fascia for soffit fixed track available in 2000, 2500, 3000, 3500, 4000 and 6000mm lengths	F160/****
	Satin anodised aluminium fascia for face fixed track available in 2000, 2500, 3000, 3500, 4000 and 6000mm lengths	F200/****
Stop	Retaining stop mounted within track	601P

\*\*\*\* replace by length of track for full short code

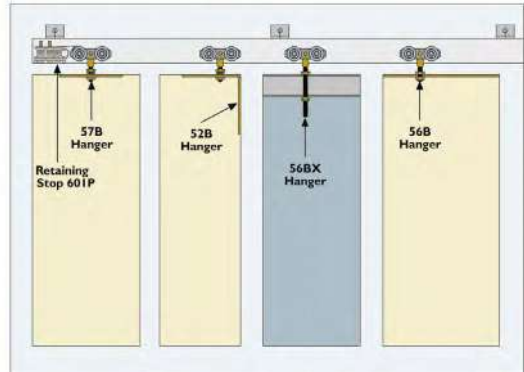
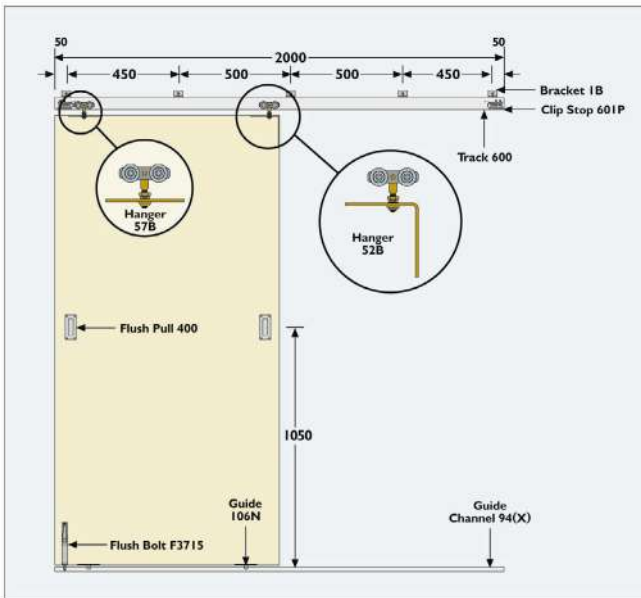
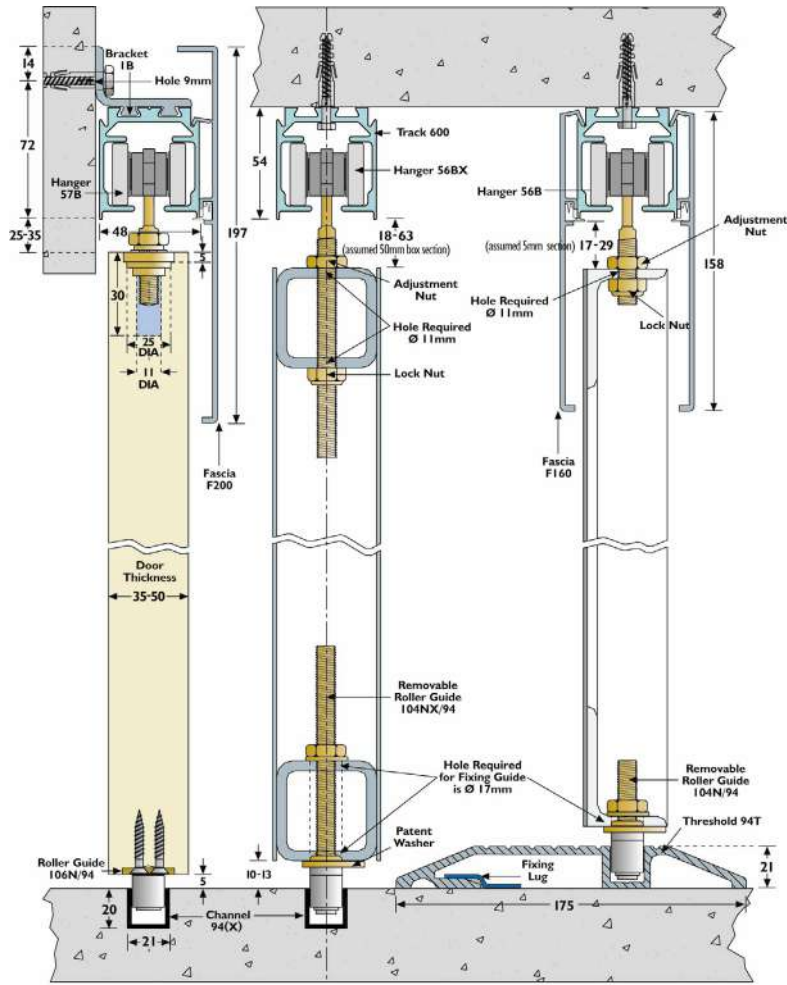

Accessories



F160 Fascia Endcap Pack (F160/ECP)



F200 Fascia Endcap Pack (F200/ECP)

View our full range of door handles and flush pulls on pages 128 and 129.

# IMPERIAL

For bottom rolling sliding wooden doors weighing up to 200kg



Imperial is ideal for bottom rolling patio doors and straight sliding room partitions that suit both residential and commercial applications. The bottom rolling system allows the system to be installed where there is insufficient support for a top hung system and therefore requires very little major structural support. To cover the width of opening, any number of doors can be used on single or multiple lines of track; doors can also slide to one or both sides.

Ready-made kit packs are available as locking and non-locking versions. The locking versions come complete with a high security 6 hook lock and keep plate. To allow increased flexibility Imperial is also able to be specified as individual parts if you would like to put together a unique system to better suit your individual requirements.

## Product Information

Product	Kit Short Code	Track Length	No of Doors	Max. Door Height	Max. Door Width	Door Thickness Range	Max. Door Weight
Imperial (Specified)	-	-	-	3000mm	-	-	100kg/200kg
Imperial Patio Kit Locking	IMPATIO/L	3000mm	1	2400mm	1500mm	40 - 56mm	200kg
Imperial Patio Kit Non Locking	IMPATIO/NL	3000mm	1	2400mm	1500mm	40 - 56mm	200kg

Note: Doors must be constructed with bottom rails of at least 150mm depth to accommodate the concealed, morticed bottom rollers. Door weight is carried on the floor permitting the use of a light overhead structure.

## Kit Contents

Component	Short Code
Bronze Bottom Rail (x 1)	915B/3000
Polypropylene Channel (x1)	94P/3000
Stainless Steel Door Stops (x 2)	DS200/SS
2.4m Interlocking Profile (x 2)	INTPROF/24
Stainless Steel Twin Wheel Rollers (x 2)	200SS
Heavy Duty Stainless Steel Top Guides(x 2)	261SS/900
6 Hook Lock Kit (x 1) (included in Imperial Locking Kit only)	-

\*\*\*\* replace by length of track for full short code

Product Specification

Component	Description	Short Code
Top Guide Channel Doors Less than 100kg	Aluminium channel available in 1500, 2000, 2500, 3000, 4000 and 6000mm lengths	94X/****
	Polypropylene channel available in 2000, 2500, 3000, 3500, 4000, 5000 and 6000mm lengths	94P/****
	Aluminium support channel (to be used in conjunction with 94P channel) available in 2000, 3000, 4000 and 6000mm lengths	94SC/****
	Stainless steel channel available in 2000 and 3000mm lengths	89/****SS
Top Guide Channel Doors 100kg to 200kg	Aluminium with safety lip available in 2000, 3000, 4000 and 6000mm lengths.	900AN/****
Bottom Rail Doors Less than 100kg	Aluminium mill finish bottom rail available in 1500, 2000, 3000, 4000 and 6000mm lengths	915A/****
Bottom Rail Doors 100kg to 200kg	Bronze bottom rail available in 1500, 2000, 2500, 3000, 4000 and 6000mm lengths	915B/****
Brackets Fitted at 900mm maximum centres	Stainless steel face fixed bracket (compatible with 900AN)	1/SS
Top Guide Rollers 2 Per Door Doors Less than 100kg	Top plate fitting top guide for 94 channel	106HSS/94
	Corner fitting top guide for 94 channel	113SS/94
	Torpedo HDPE fitting top guide complete with stainless steel screws - for 89 or 94 channel	89/2N/SS
Top Guide Rollers 2 Per Door Doors 100kg to 200kg	Stainless steel top guide with double nylon rollers, one adjustable laterally to prevent rattle - for 900AN channel	261SS/900
Bottom Rollers 2 per door	Stainless steel bottom roller with precision ball bearing wheels with side access vertical adjustment	200SS
Interlocking Profile	Interlocking profile 2.4m	INTPROF/24
Stops	Floor stop	DS200/SS
	Track mounted stop for 900AN Channel	HH2/SS

IMPERIAL

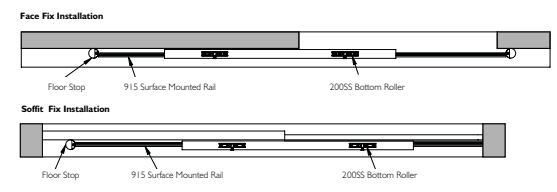
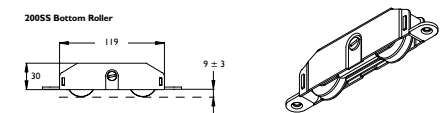
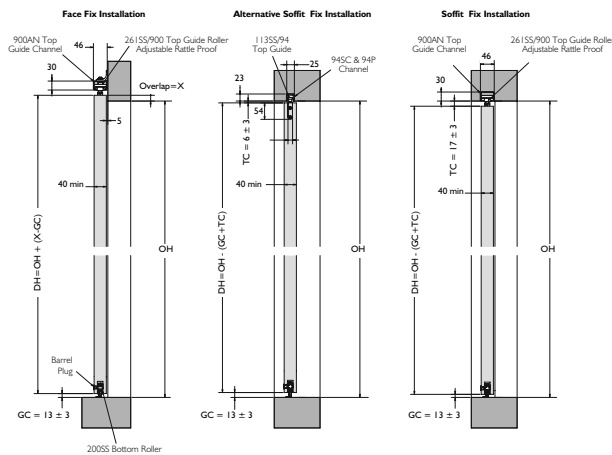

IMPERIAL PATIO KIT

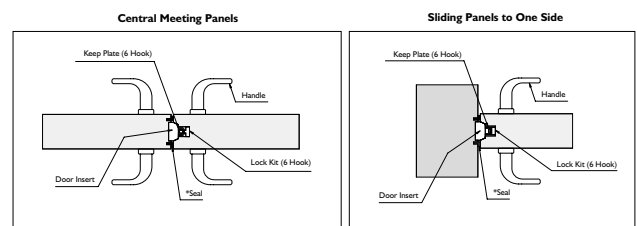
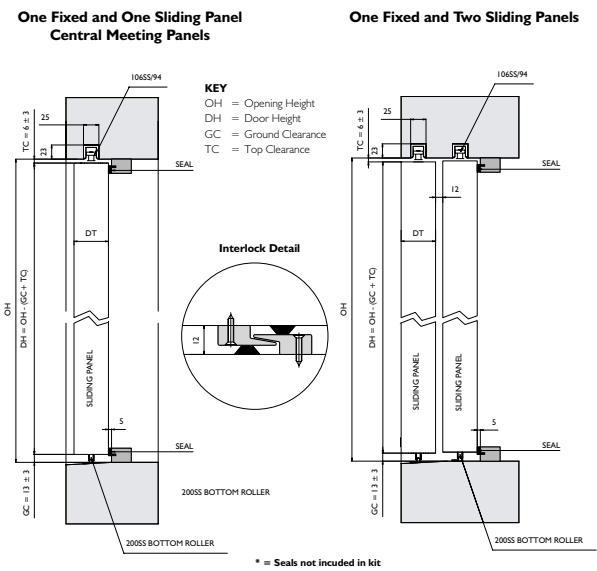

Accessories

View our full range of door handles and flush pulls on pages 128 and 129.





# SOLTAIRE

Top hung straight sliding door system for doors weighing up to 120kg, 180kg and 250kg



Soltaire is a beautifully crafted top hung sliding system designed to accommodate interior and exterior doors of one sliding panel or two bi-parting doors on a single track. Designed for door weights up to 120kg, 180kg or 250kg the reliable system is extremely durable and weather resistant due to its 316 stainless steel components. The track can be soffit fixed or face fixed for flexibility of installation.

Ready-made kit packs are available as separate external and internal systems for Soltaire 120 and kits that cater for both types of applications for Soltaire 180 and 250. To allow increased flexibility Soltaire is able to be specified as individual components if you would like to put together a unique system to better suit your individual requirements, see page 43 for details.

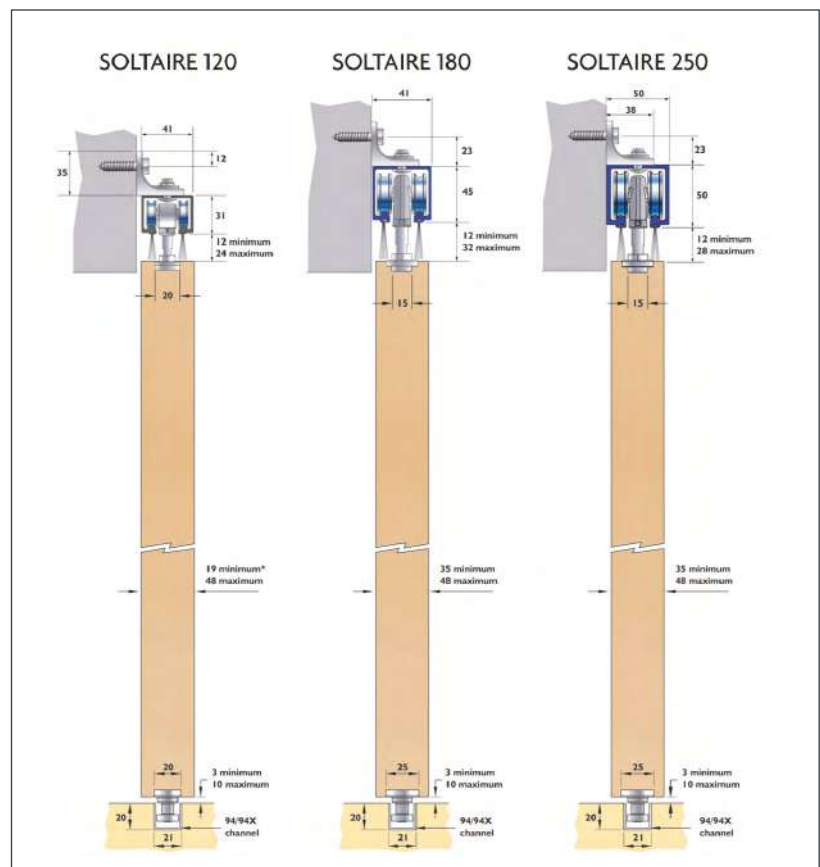

## Product Information

Product	Kit Short Code: Internal	Kit Short Code: External	Track Length	No. of Doors	Max. Door Height	Max. Door Width	Door Thickness Range	Max. Door Weight
Soltaire 120*	S120/20ANI	S120/20AN	2000mm	1	3000mm	1000mm	19 – 48mm	120kg
Soltaire 180*	S180/30AN		3000mm	1	3000mm	1500mm	35 – 48mm	180kg
Soltaire 250*	S250/30AN		3000mm	1	3000mm	1500mm	35 – 48mm	250kg

\*Can also be specified as individual components to suit specific project requirements, see page 43 for details

## Kit Contents

Component	Soltaire 120 Internal	Soltaire 120 External	Soltaire 180	Soltaire 250
Track	120/2000 (x1)	120/2000 (x1)	180/3000 (x1)	250/3000 (x1)
Hangers	51/120/SS (x2)	51/120/SS (x2)	57/180/SS (x2)	57/250/SS (x2)
Guide	101SS (x1)	106SS/94 (x2)	106HSS/94 (x2)	106HSS/94 (x2)
Track Stops	- (x2)	- (x2)	- (x2)	- (x2)
Face Fix Brackets	- (x4)	- (x4)	- (x5)	- (x5)
Flush Pulls	144S (x2)	144S (x2)	144S (x2)	144S (x2)
Guide Channel	-	94X/2000 (x1)	94X/3000 (x1)	94X/3000 (x1)

## Product Specification

Component	Description	Soltaire 120 Short Code	Soltaire 180 Short Code	Soltaire 250 Short Code
Track	Anodised aluminium track in 2000, 2500, 3000, 3500, 4000, 5000 and 6000mm lengths	120/****	180/****	250/****
Brush Strips	Brush track seal in black in 10, 15, 20 and 25mm lengths	BS**B/120	BS**B	BS**B
Brackets	Face fixed stainless steel bracket (600mm spacing)	1/SS	1/SS	1/SS
	Face fixed double run stainless steel bracket (900mm spacing)	5/SS	5H/SS	5H/SS
Hangers	Face fixing hanger for MDF doors	52/120/SS	-	-
	Top fixed, surface mounted hanger for wooden doors	51/120/SS	-	-
	Concealed plate fixing hanger for wooden and metal doors	57/120/SS	57/180/SS	57/250/SS
	Corner plate fixing hanger for wooden doors	-	52/180/SS	52/250/SS
	Saddle plate fixing hanger for wooden doors	-	53/180/SS	53/250/SS
	Angle frame hanger for wooden doors	56/120/SS	56/180/SS	56/250/SS
	Box frame hanger for metal doors	-	56X/180/SS	56X/250/SS
Guides	Concealed fixing guide with stainless steel bearings	106SS/94	106HSS/94	106HSS/94
	Fixed guide	101SS	101SS	101SS
	Wall mounted guide	102SS/94	102SS/94	102SS/94
	Guide for angle frame metal door	104P/89	104P/89	104P/89
	Guide for box section metal door	104PX/89	104PX/89	104PX/89
Channels Track Stop	Aluminium guide channel in 1500, 2000, 2500, 3000, 4000 and 6000mm lengths	94X/****	94X/****	94X/****
	Stainless steel channel available in 2000 and 3000mm lengths	89/****SS	89/****SS	89/****SS
	Polypropylene channel in black available in 2000, 3000, 3500, 4000, 5000 and 6000mm lengths	94P/****	94P/****	94P/****
	Anodised aluminium support channel available in 2000, 3000, 3500, 4000, 5000 and 6000mm lengths - to be used in conjunction with 94P channel	94SC/****	94SC/****	94SC/****
	Track stop	HH4/SS	HH5/SS	HH5/SS

\*\*\*\*Replace with length of track for full short code \*\* Replace with length of brush strip for full short code

## Accessories

### Soft Close Kits - for use with Soltaire 120 kits only

Single Damper Short Code	Double Damper Short Code	Min. Door Width	Max. Panel Height	Max. Panel Width	Max. Door Weight
51SD80	51SD80D	600mm	3000mm	24 - 48mm	80kg
52SD80	52SD80D	600mm	3000mm	19 - 23mm	80kg
56SD80	56SD80D	600mm	3000mm	19 - 48mm	80kg
57SD80	57SD80D	600mm	3000mm	24 - 48mm	80kg

### Low Headroom Kits\*



Soltaire 120 Low Headroom Kit (LH120)



Soltaire 180 Low Headroom Kit (LH180)



Soltaire 250 Low Headroom Kit (LH250)

**View our full range of door handles and flush pulls on pages 128 and 129.**

\*Cannot be used in conjunction with Soltaire Soft Close Kits



# STAINLESS STEEL

A stainless steel tailor made solution for light to heavyweight sliding doors exposed to high levels of corrosion



For areas exposed to extreme levels of corrosive elements or where a high level of hygiene is essential, P C Henderson has developed a range of stainless steel sliding door hardware. Manufactured from high quality stainless steel and incorporating the latest polymers, this product offers a high level of performance and corrosion resistance.

Stainless Steel can be used for an array of applications including chemical factories, oil rigs, abattoirs, cold storage, food processing plants and areas exposed to salt water. Whatever the conditions, Stainless Steel will perform.

## Product Information

Product	Max. Door Height	Door Thickness Range	Max. Door Weight
Stainless Steel 280	2400mm	20 - 50mm	50kg/100kg
Stainless Steel 290	3000mm	35 - 48mm	150kg
Stainless Steel 301	3600mm	43 - 57mm	270kg

## Product Specification

Component	Description	SS 280	SS 290	SS 301
Track	Grade 316L(A4) stainless steel track available in 2000 and 3000mm lengths	280/****SS	290/****SS	301/****SS
Hangers	Hanger for wooden doors	284N/SS (50kg) or 284/SS (100kg)	-	-
	Hanger for metal doors	285N/SS (50kg) or 285/SS (100kg)	56/290SS	56/301SS
	Hanger for apron plate fixing	-	53/290SS	53/301SS
	Hanger for top plate fixing	-	57/290SS	57/301SS
Brackets	Face fixed bracket	281SS	1/290SS	1/301SS
	Face fixed jointing bracket	-	1X/290SS	1X/301SS
	Soffit fixed bracket	-	3/290SS	3/301SS
	Soffit fixed jointing bracket	-	3X/290SS	3X/301SS
	'In line' soffit fixed bracket	-	4/290SS	4/301SS
	'In line' soffit fixed jointing bracket	-	4X/290SS	4X/301SS
	'Bolt on' soffit fixed bracket	4R/280SS	4R/290SS	4R/301SS
	'Bolt on' soffit fixed jointing bracket	4RX/280SS	4RX/290SS	4RX/301SS
Channel	Stainless steel channel in 2000 or 3000mm lengths	89/****SS	89/****SS	89/****SS
Guides	Single door floor guide	89/2N/SS	89/2N/SS	89/2N/SS
	Wall mounted guide for single door	31S/SS	31S/SS	31S/SS

Note: Fixing plates, bolts and nuts are Grade 402 (A2) Stainless Steel. The Stainless Steel range cannot be used with P C Henderson's standard range of products

## 280/SS

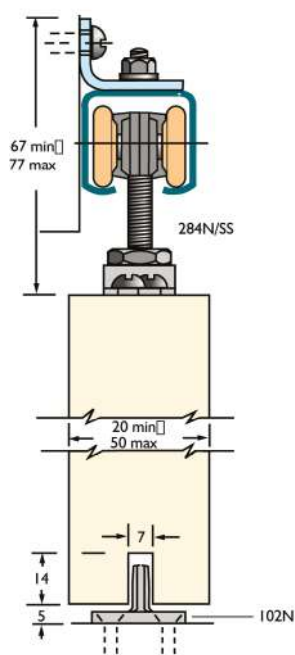

## 290/SS

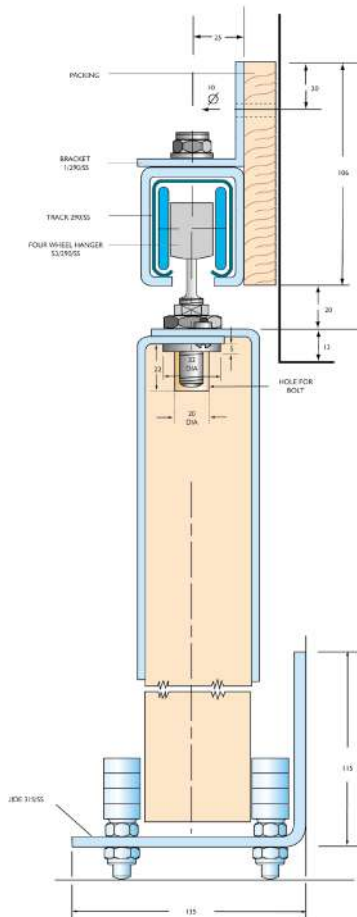

## 301/SS

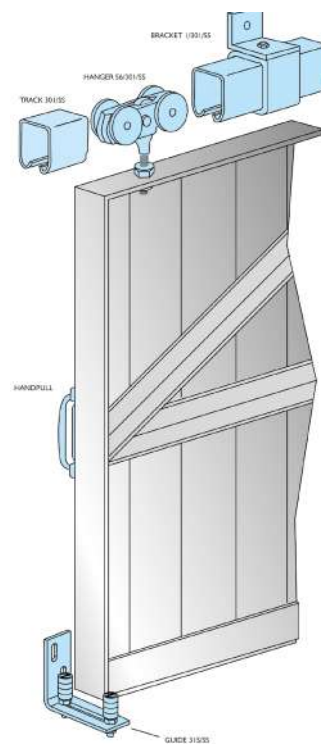
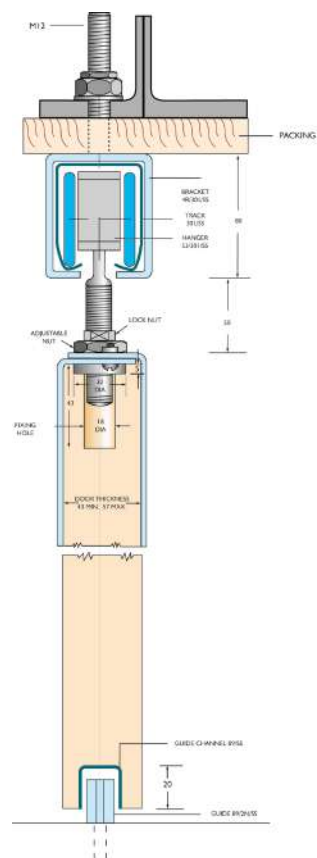

Stainless Steel component drawings can be found on page 126.

## Accessories



Single Buffer or Wall Mounted Stop (109/SS)



Track Stop (287SS)



Stainless Steel 290 Track Stop (HH3/290/SS)



Stainless Steel 301 Track Stop (HH3/301/SS)

View our full range of door handles and flush pulls on pages 128 and 129.



# MAJESTIC

For bottom rolling straight sliding doors weighing up to 270kg



Majestic is a durable system perfectly suited for heavy high class joinery installations weighing up to 270kg. Majestic features a concealed bottom roller enabling the weight of the door to be 'transferred to the bottom track, making it ideal for applications where there is not enough structural support to carry a top hung system.

**Please note:** At least 175mm depth at the bottom of the door must be available to accommodate the concealed bottom rollers when choosing this system.

## Product Information

Product	Max. Door Height	Door Thickness Range	Max. Door Weight
Majestic	3300mm	44 - 57mm	270kg

## Product Specification

Component	Description	Short Code
Top Guide Channel Twice the width of doors	Galvanised steel top guide channel with safety lip available in 2000, 2500 and 3000mm lengths.	900/****
Brackets Fix every 900mm max and at channel joints	Face fixed single track bracket	1/900
	Soffit fixed single track bracket	3/900
	Face fixed double track bracket	5/900
Top Guide Rollers 2 per door	Top guide rollers with concealed edge fixings and double adjustable anti-rattle rollers	203/900
Bottom Rollers 2 per door	Brass wheel bottom roller with maintenance free roller bearing	916
Bottom Rail	Brass bottom rail available in 1500 and 3000mm lengths. Drilled and countersunk - lugs and couplers available for fixing rail to concrete	917/****
	Brass recessed bottom rail available in 1500 and 3000mm lengths.	817/****
Stop	See accessories for options	-

\*\*\*\* replace by length of track for full short code



SECTION DETAILS

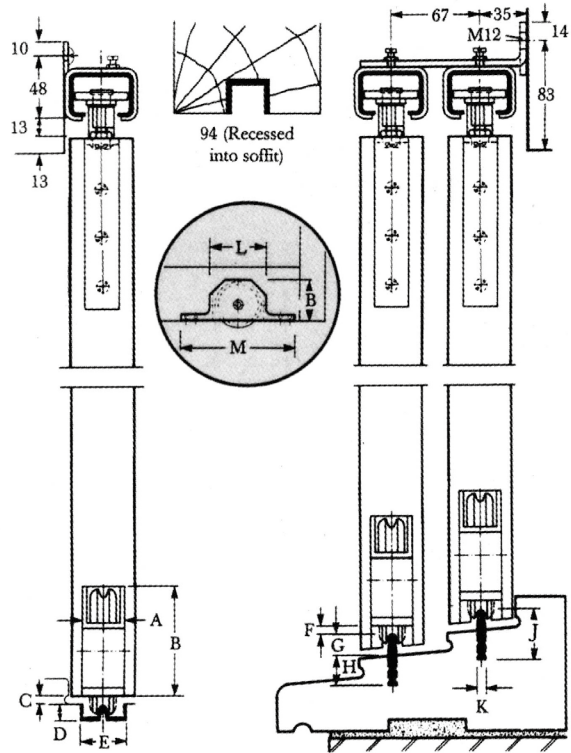

Dimensions											
A	B	C	D	E	F	G	H	J	K	L	M
32	82	6	13	35	6	16	22	38	8	111	229

CHOICE OF GEARS

Guide Channels



Face Fixed Brackets

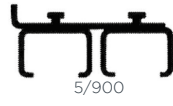

Soffit Fixed Brackets



Guide

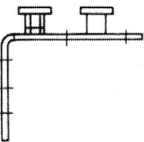

Bottom Rollers

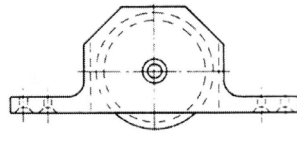

Brass Bottom Rails



EXAMPLE PLAN DETAILS

Single Run

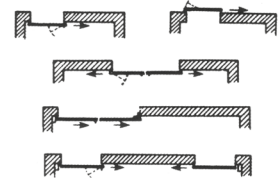

Double Run

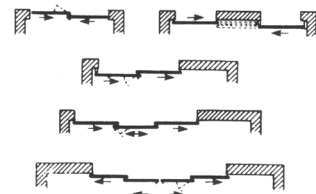

Accessories



Zinc Plated Steel Door Stop With Double Rubber Buffers (107)



Zinc Plated Door Stop With Rubber Buffer (109)



Stainless Steel Door Stop with Rubber Buffer (109/SS)



Lug for Fixing Rails into Concrete (917/918 Lug)



Cup for Fixing Rails into Concrete (917/918 Cup)

View our full range of door handles and flush pulls on pages 128 and 129.

# FLEXIROL SLIDING

For sliding wooden or metal doors weighing up to 500kg



Flexirol is a unique system ideally suited to large doors which require high performance as well as an attractive finish. It's an ideal product for hotels, offices, conference centres, shop fronts and showrooms where durability and design are paramount. The product caters for wooden or metal doors fabricated from either angle frame or box section with aluminium extrusion. The track can be soffit fixed or face fixed for flexibility of installation.

## Product Information

Product	Max. Door Height	Max. Door Width	Door Thickness Range	Max. Door Weight
Flexirol Sliding	6000mm	6000mm	40 - 100mm	500kg

## Product Specification

Component	Description	Short Code
Track	White aluminium track available in 2000, 3000, 4000, 5000 and 6000mm lengths	550/****
	Mill finish track available in 2000, 3000, 4000, 5000 and 6000mm lengths	550/****M
Brackets Spaced every 750mm	Face fixed bracket	1A/550
	Suspended soffit fixed ceiling bracket with vertical adjustment	3S/550
Hangers 2 per door	Hanger for metal doors	556
	Hanger for wooden doors with concealed fixing	556/57
	Hanger for wooden doors with angle plate fixing	556/52
Guides	Guide for wooden and metal doors, 1 per door (metal doors should also use 94X channel)	89/2N
	Guide for wooden doors, 2 per door	106N/94
	Guide for metal doors, 2 per door	104N/94
	Guide for metal doors, extended version, 2 per door	104NX/94
Guide Channel	Brass guide channel available in 1500 and 3000mm lengths	94/****
	Aluminium guide channel in 1500, 2000, 2500, 3000, 4000 and 6000mm lengths	94X/****
	Aluminium threshold guide channel available in 2000, 2500, 3000, 3500, 4000, 6000mm lengths	94T/****

\*\*\*\*Replace with length of track or rail for full short code



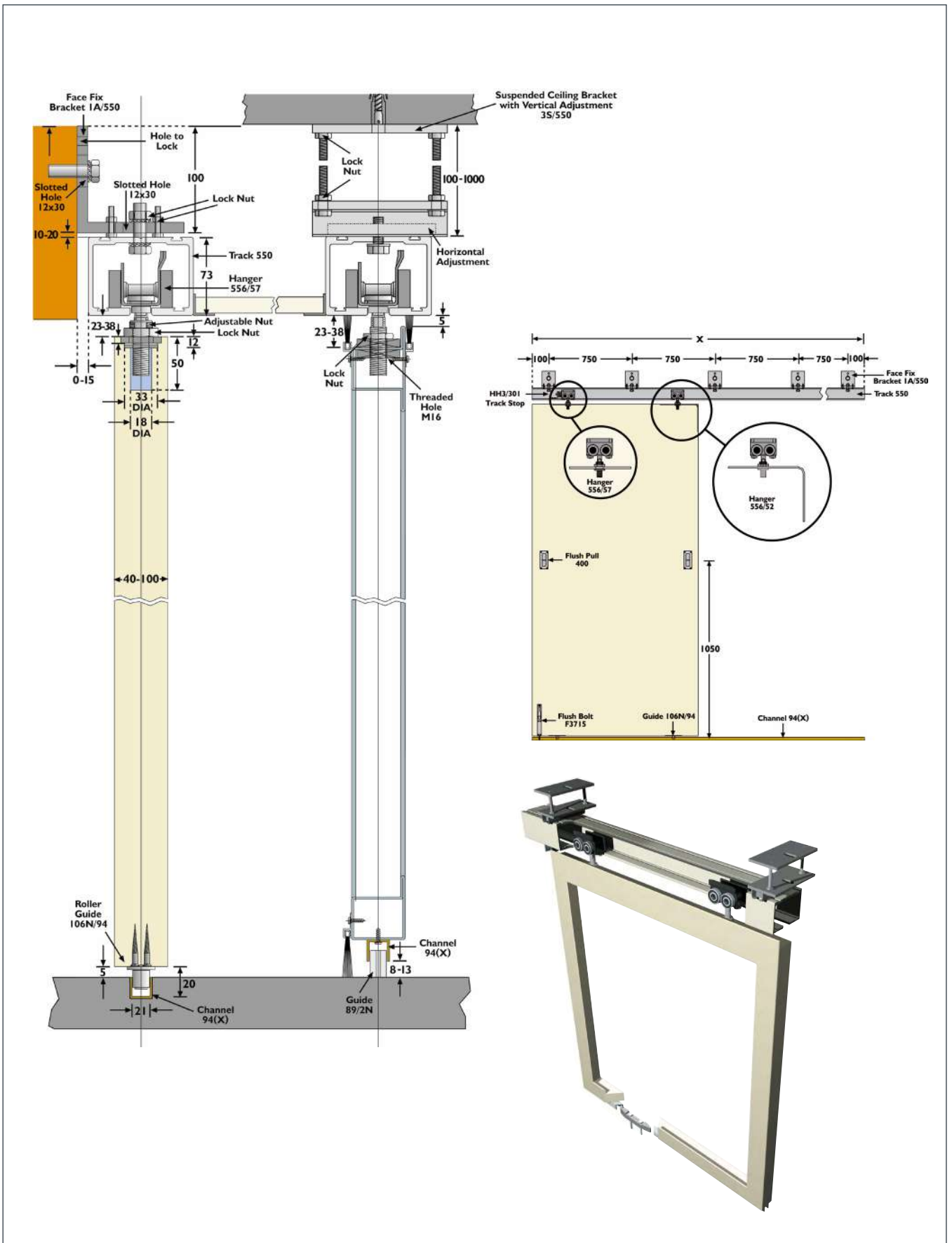

Accessories



Track Stop (HH3/301)

View our full range of door handles and flush pulls on pages 128 and 129.



# FLEXIROL SLIDING GLASS

For sliding glass doors weighing up to 500kg



Flexirol Sliding Glass is a unique system ideally suited to large doors that require high performance as well as an attractive finish. It's an ideal product for hotels, offices, conference centres, shop fronts and showrooms where durability and design are paramount.

## Product Information

Product	Max. Door Height	Min. Door Width	Glass Thickness	Max. Door Weight
Flexirol Sliding Glass	4000mm	1000mm per 100kg of glass	10mm or 12mm	500kg

## Product Specification

Component	Description	Short Code
Track	White aluminium track available in 2000, 3000, 4000, 5000 and 6000mm lengths	550/****
	Mill finish track available in 2000, 3000, 4000, 5000 and 6000mm lengths	550/****M
Brackets Spaced every 750mm	Face fixed bracket	1A/550
	Suspended soffit fixed ceiling bracket with vertical adjustment	3S/550
Hangers 2 per door	Hanger with mounting block	556S
Glass Profile	Made to measure	FRP02
Guides 2 per door	Guide with mounting block	FRPN/94
Guide Channel	Brass guide channel available in 1500 and 3000mm lengths	94/****
	Aluminium guide channel in 1500, 2000, 2500, 3000mm lengths	94X/****
	Aluminium threshold guide channel in 2000, 2500, 3000, 3500, 4000 and 6000mm lengths	94T/****
Stop 2 per door	Track stop	HH3/301

\*\*\*\*Replace with length of track or rail for full short code

## Accessories

**View our full range of door handles and flush pulls on pages 128 and 129.**

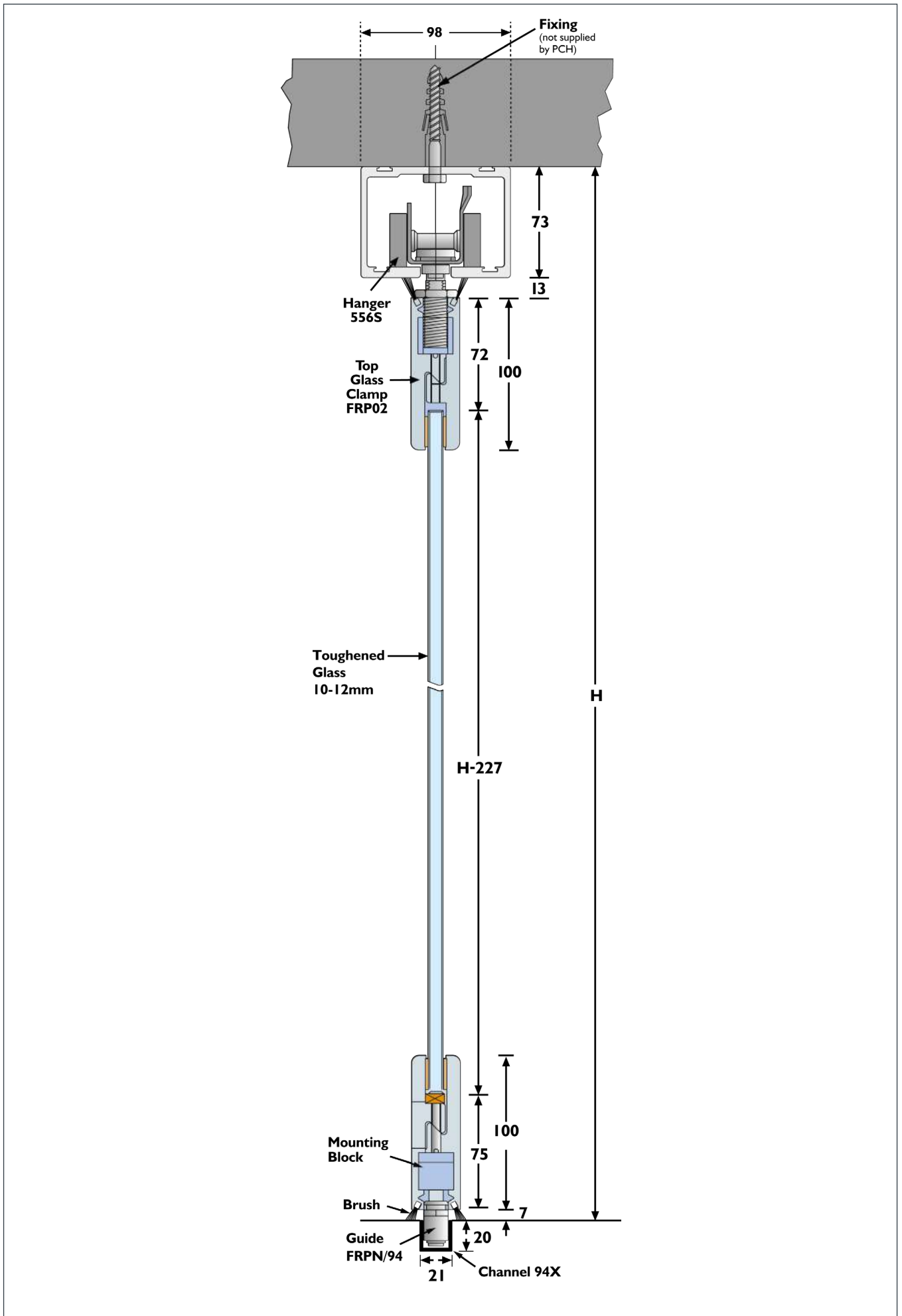

# STRAIGHT SLIDING <sup>290, 301, 301H, 305, 307</sup>

For straight sliding wooden and metal doors for maximum door weights of between 150kg and 2000kg



Our Straight Sliding system for wooden and metal doors is a wide range of top hung systems for easy movement of anything from light commercial doors up to very heavy and large industrial applications. Seven systems are available for doors weighing up to a maximum of 2000kg. To accommodate different building designs, doors can slide to one or both sides and are also suitable to cover any width of opening. For optimum operation the door width should not exceed three quarters of the door height.

## Product Information

Product	Max. Door Height	Door Thickness Range	Max. Door Weight (Nylon Hanger)	Max. Door Weight (Steel Hanger)
Straight Sliding 290	3000mm	35 - 48mm	150kg	200kg
Straight Sliding 301	3600mm	43 - 57mm	400kg	300kg
Straight Sliding 301H	4200mm	43 - 57mm	450kg	-
Straight Sliding 305	4800mm	43 - 57mm	-	700kg
Straight Sliding 307	6000mm	60 - 70mm	-	2000kg

## Product Specification

Component	Description	290 Short Code	301 Short Code	301H Short Code	305 Short Code	307 Short Code
Track Twice the width of doors	Galvanised steel track in 2000, 2500, 3000, 4000, 5000 and 6000mm lengths (for 307, 5000mm and 6000mm lengths are unavailable)	290/**** 2mm thickness	301/**** 2mm thickness	301H/**** 3mm thickness	305/**** 3mm thickness	307/**** 5mm thickness
Brackets Steel 900mm max spacing and at track joints *Bracket configuration available in aluminium	Face fixed	1/290S	1/301S	1/301S	-	1/307/S
	Face fixed left closed	1/290SLC	1A/301EC To close	1A/301EC To close	-	1/307/SLC
	Face fixed right closed	1/290SRC	1A/301EC To close	1A/301EC To close	-	1/307/SRC
	Face fixed jointing	1X/290S	1X/301/S	1X/301/S	-	1X/307/S
	Face fixed low headroom	9/290	9/301S	9/301S	-	9/307/S
	Face fixed low headroom left closed		1A/301EC To close	1A/301EC To close	-*	9/307/SLC
	Face fixed low headroom right closed		1A/301EC To close	1A/301EC To close	-*	9/307/SRC
	Face fixed low headroom jointing	9X/290	9X/301S	9X/301S	-*	9X/307S
	Double face fixed adjustable	-*	5R/301/S	5R/301/S	-	5/307S
	Double face fixed closed reversible	-*	-	-	-	5/307SC
	Soffit fixed	-*	3/301S	3/301S	-	3/307/S
	Soffit fixed closed	-*	1A/301EC To close	1A/301EC To close	-*	3/307SC
	Soffit fixed jointing	-*	3X/301S			3X/307S
	Soffit fix 'in line'	-*	4/301S	4/301S	-	4/307/S
	Soffit fix 'in line' closed	-*	1/301EC To close	1/301EC To close		4/307/SC
	Soffit fix 'in line' jointing	-*	4X/301S	4X/301S	-*	4X/307S
	Soffit fix adjustable	4R/290S	4R/301S	4R/301S	4R/305S	4R/307S
	Soffit fix adjustable jointing	4RX/290S	4RX/301TS	4RX/301TS	4RX/305	4RX/307S
	Soffit fix adjustable track sleeve	-	4RX/301TS	4RX/301TS	-	-
	Bracket body (for welding)	4R/290SB	-	-	4R/305SB	4R/307SB
	Triple face fix	-	7/301S	7/301S	-	-
	Triple face fix left closed	-	7/301SLC	7/301SLC	-	-
	Triple face fix right closed	-	7/301SRC	7/301SRC	-	-
	Triple soffit fix	-	8/301S	8/301S	-	-
	End clip to close bracket		1A/301EC	1A/301EC	-	-
	Double soffit fix 'in line'	-	6/301S	6/301S	-	-

## Product Specification - continued

Component	Description	290 Short Code	301 Short Code	301H Short Code	305 Short Code	307 Short Code
Brackets Aluminium 900mm max spacing and at track joints *Bracket configuration available in steel **Steel product	Face fix	1A/290	1A/301	1A/301	1A/305	-*
	Face fix left closed	-	-	-	1A/305LC	-*
	Face fix right closed	-	-	-	1A/305RC	-*
	Face fix jointing	1AX/290	1AX/301	1AX/301	1AX/305	-*
	Face fix low headroom open	-	-	-	9A/305**	-*
	Face fix low Headroom	-	-	-	9A/305LC**	-*
	Face fix low headroom jointing	-	-	-	9A/305RC**	-*
	Soffit fix	3A/290	3A/301	3A/301	3A/305	-*
	Soffit fix closed	-	-	-	3A/305C	-*
	Soffit fix jointing	3AX/290	3AX/301	3AX/301	3AX/305	-*
	Soffit fix 'in line'	4A/290	4A/301	4A/301	4A/305	-*
	Soffit fix 'in line' closed	-	-	-	-	-*
	Soffit fix 'in line' closed	4AX/290	4AX/301	4AX/301	4AX/305	-*
	Double face fix	5/290	5/301	5/301	-	-*
	Double face fix left closed	-	-	-	-	-*
	Double face fix right closed	-	-	-	-	-*
	Double soffit fix 'in line'	-	-	-	-	-*
End clip to close bracket	1A/290EC	1A/301EC	1A/301EC	-	-	
Hangers 2 per door /s = steel wheel /n = nylon wheel	Metal door - 4 wheel - standard bolt	56K/S	56A/S	56A/S	56C/S	56FJ/S
	Metal door - 4 wheel - standard bolt	56K/N	56A/N	56A/N	-	-
	Metal door - 4 wheel - standard bolt	56K/S200	-	-	-	-
	Metal door - 4 wheel - standard bolt	56KN200	-	-	-	-
	Metal door - extended bolt	56KX/S	56AX/S	56AX/S	56CX/S	56FJX/S
	Metal door - extended bolt	56KX/N	56AX/N	56AX/N	-	-
	Metal door - fire door	-	56AF/S	56AF/S	56CF/S	-
	Metal door - 2 wheel - standard bolt	56.5K/S	56.5A/N	56.5A/N	-	-
	Metal door - 2 wheel - standard bolt	56.5K/N	56.5A/N	56.5A/N	-	-
	Wood door - 4 wheel - side plates	53K/S	53A/S	53A/S	53C/S	53FJ/S
	Wood door - 4 wheel - side plates	53K/N	53A/N	53A/N	-	-
	Wood door - 4 wheel - side plates	53K/S200	-	-	-	-
	Wood door - 4 wheel - top plates	57K/S	57A/S	57A/S	57C/S	-
	Wood door - 4 wheel - top plates	57K/N	57A/N	57A/N	57A/N	-
	Wood door - 4 wheel - top plates	57K/S200	-	-	-	-
	Wood door - 4 wheel - angle plates	52K/S	52A/S	52A/S	52C/S	-
	Wood door - 4 wheel - angle plates	52K/N	52A/N	52A/N	-	-
	Wood door - 4 wheel - angle plates	52K/S200	-	-	-	-
	290 hanger with metal body	56MVS	-	-	-	-
Guide Channel Same length as track	Galvanised steel channel in 2000, 2500, 3000, 4000 and 6000mm lengths.	89/****	97/****	97/****	97/****	97/****
	Brass channel available in 1500 and 3000mm lengths	94/****	-	-	-	-
	Aluminium channel available in 1500, 2000, 2500 and 3000mm lengths	94X/****	-	-	-	-
	Shallow steel channel available in 2000, 2500, 3000 and 4000mm lengths	-	100/****	100/****	100/****	100/****
	Bottom rail for non-clog guide available in 2000, 2500 and 3000mm lengths	299	299	299	299	299
	Fixing lugs for concrete**	97LUG	-	-	-	-
	Channel coupler*	97CUP	-	-	-	-
Guides	Metal door	104P/89	104P/97	104P/97	104P/97	104P/97
	Wood door - face fixed	105R/89	105R/97	105R/97	105R/97	105R/97
	Wood door - self cleaning	-	102/97	102/97	102/97	102/97
	Wood door - flat plate	106R/94	106R/97	106R/97	106R/97	106R/97
	Wood door - end fix	113R/94	-	-	-	-
	Metal door - extended	104PX/89	104PX/97	104PX/97	104PX/97	104PX/97

\*\*\*\*Replace with length of track or rail for full short code \*All channels supplied with lugs and couplers included except 94 and 94X



# STRAIGHT SLIDING CONTINUED

## FOR WOOD DOORS



### SECTION DETAILS

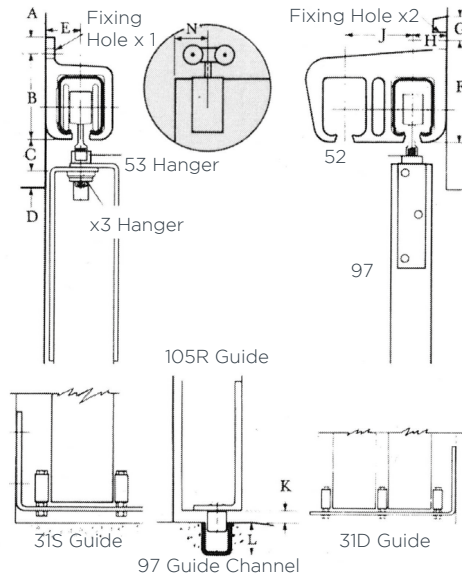

Track	A	B	C	D	E	F	G	H	J	K	L	X1	X2	X3	N
280	7	40	20	12	16						10	25	M5		*
290	13	67	25	13	27	80	20	27	54	10	25	M8	M12	11	48
301/301H	20	97	50	25	35	110	33	39	79	10	38	M12	M16	20	75
305	25	140	50	25	38	155	38	48	92	13	38	M16	M20	20	85
307	24	156	67	38	45	192	26	45	91	13	38	M16	M20	25	115

\*Husky 50 (284N) = 110mm \*Husky 100 (284) = 120mm

### CHOICE OF GEARS

#### Tracks

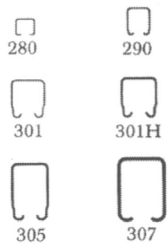

#### Brackets - Face Fixed



#### Brackets - Soffit Fixed



#### Handles

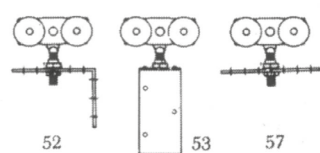

#### Guides

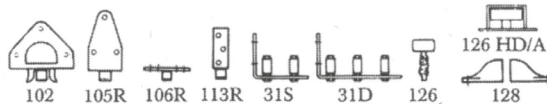

#### Guide Channels

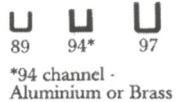

\*94 channel - Aluminium or Brass

#### Door Stops

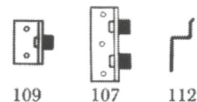

#### Track Stops



#### Handles



#### Bolts

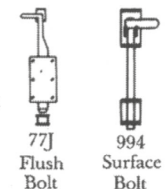

### EXAMPLE PLAN DETAILS

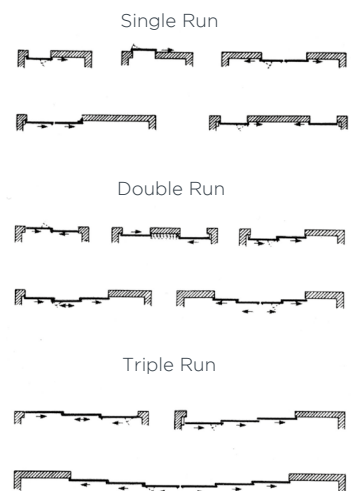

**FOR METAL DOORS**



**SECTION DETAILS**

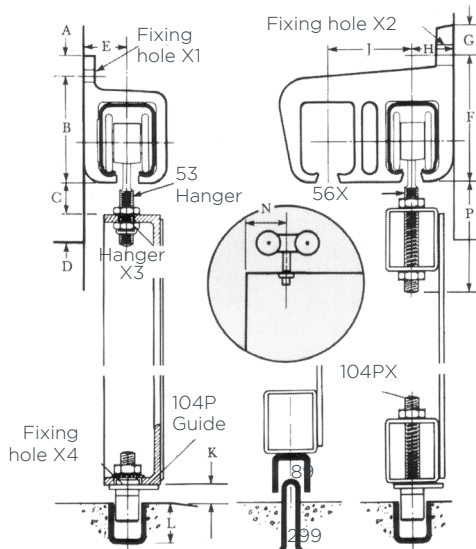

Track	A	B	C	D	E	F	G	H	J	K	L	X1	X2	X3	X4	N	P
280	7	40	20	12	16						10	25	M5	8.4	17	50	
290	13	67	25	13	27	80	20	27	54	10	25	M8	M12	10.5	17	48	1109
301/301H	20	97	50	25	35	110	33	39	79	10	38	M12	M16	17	20	75	140
305	25	140	50	25	38	155	38	48	92	13	38	M16	M20	17	20	85	140
307	24	156	67	38	45	192	26	45	91	13	38	M16	M20	21	20	115	140

**CHOICE OF GEARS**

Tracks



Face Fixed Brackets



Soffit Fixed Brackets



Hangers

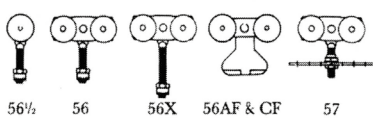

Guides

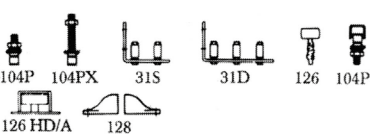

Track Stops

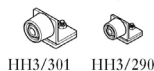

Door Stops

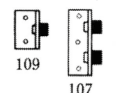

Accessories

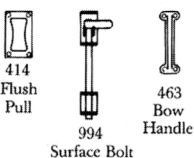

Guide Channels

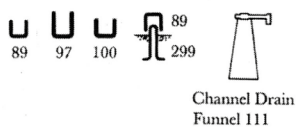

**EXAMPLE PLAN DETAILS**

Single Run

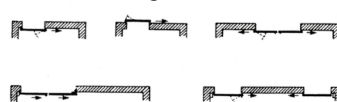

Double Run

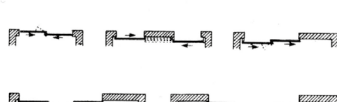

Triple Run



Accessories



Surface Bolt 380mm (994)



Locking Bolt 380mm (994S)



Offset Bolt 380mm (994X)



Stop - Buffer Only (107E)



Wall Mounted Stop with Rubber Buffer (109)



Wall Mounted Stop with Double Rubber Buffers (107)

View our full range of door handles and flush pulls on pages 128 and 129.

# STERLING

For bottom rolling wooden and metal doors weighing up to 8000kg



The Sterling range of bottom rolling systems is ideal for both commercial and industrial sliding applications. The product is particularly suitable where the supporting structure or lintel is insufficient for the weight of the door or headroom is limited. Ten systems are available in total, catering for wooden doors weighing up to a maximum of 2000kg and metal doors up to a maximum weight of 8000kg. The product is suitable for single or multiple lines of track and the top guide channel may be soffit fixed or face fixed.

## Product Information

Product	Door Material	Max. Door Height	Door Thickness Range	Max. Door Weight
Sterling 350	Wood/Metal	4000mm	44 - 54mm	350kg
Sterling 800	Wood/Metal	5200mm	54 - 63mm	800kg
Sterling 2000	Wood/Metal	7500mm	Contact PCH	2000kg
Sterling 3600	Metal	12500mm	152mm (min)	3600kg
Sterling 8000	Metal	20000mm	152mm (min)	8000kg

## Product Specification

Component	Description	350 Short Code	800 Short Code	2000 Short Code	3600 Short Code	8000 Short Code
Top Guide Channel	Galvanised steel track available in 2000, 2500 and 3000mm lengths. Track for Sterling 2000 is available in 2000 and 3000mm lengths only.	99/****	99/****	13/****	Not by PCH	
Brackets Fix at 900mm centres (max.)	Face fixed	31	31	-		
	Face fixed adjustable	-	-	1/13		
	Face fixed jointing	31X	31X	-		
	Soffit fixed and jointing	-	-	2/13		
	Double face fixed jointing	35X	35X	5/13		
Top Guide Rollers 2 per doors for all except 3600 and 8000 systems which require 4 per door	Double face fixed	35	35	-	104S/125 104S/175 104S/200 104S/125 104S/175 104S/200	
	Metal door - 7000mm height	-	-	-		
	Metal door - 12500mm height	104/99	104/99	-		
	Metal door - 20000mm height	-	-	104/13		
	Wooden door - saddle fixing	53/99	53/99	53/13		
Bottom Rollers 2 per door. Zinc plated and maintenance free, sealed for life roller bearing	Wooden door - corner plate fixing	-	-	-	-	-
	Metal door for standard rail (wheel and bolt on only)	1SU	3SU	4SJU	-	-
	Metal door for V tread rail (wheel and bolt on only)	1SV	3SV	4SJV	-	-
	Metal door for square tread rail (wheel and bolt on only)	1SL	3SL	4SJL	-	-
	Metal door - standard roller	1S	3S	4SJ	3600IR	8000IR
	Metal door - geared	-	-	-	3600GO	8000GO
Bottom Rail	Wooden door	2	3	4J	-	-
	Galvanised steel in 2000, 2500, 3000mm lengths	298/****	298/****	298/****	-	-
	Heavy steel section available in 2700mm lengths	-	-	-	297/****	297/****

\*\*\*\*Replace with length of track or rail for full short code

## FOR WOOD DOORS

### SECTION DETAILS

NB: Top section of the door illustrated in only Sterling 350 & 800.

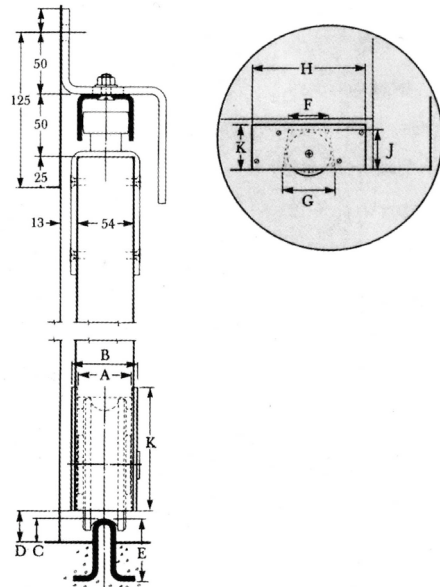

### Dimensions

Track	A	B	C	D	E	F	G	H	J	K
350	44	54	20	25	50	115	135	305	95	102
800	51	63	20	30	50	135	175	381	130	152

## CHOICE OF GEARS

Guide Channels Face Fixed Brackets



Guides for Wood Doors

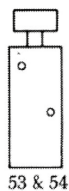

53 & 54

Doors Stops

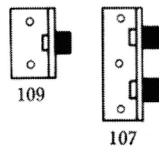

109  
107

Bottom Rollers for Wood Doors

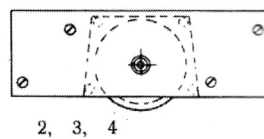

2, 3, 4

### EXAMPLE PLAN DETAILS

Single Run

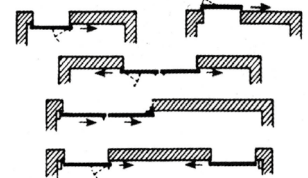

Double Run

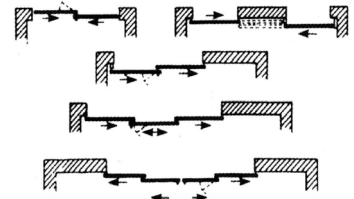

Bottom Rails



298

Handles

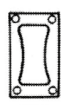

414  
Flush Pull



463  
Bow Handle

Bolts

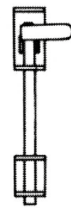

994  
Surface Bolt

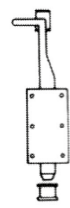

77J  
Flush Bolt



# STERLING CONTINUED

## FOR METAL DOORS

Section Details

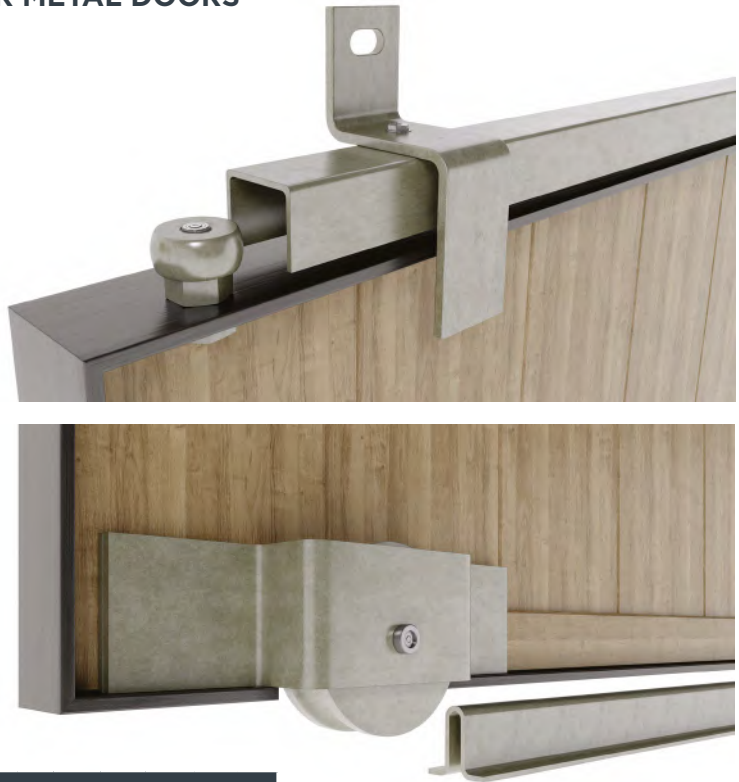
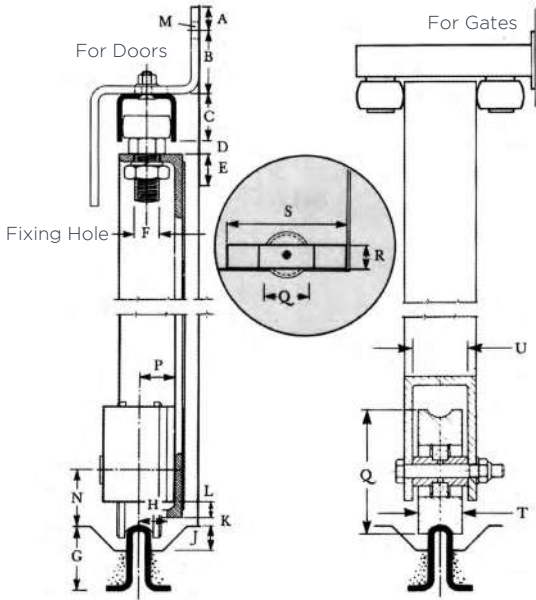

Dimensions

Track	A	B	C	D	E	F	G	H	J	K	L	M	N	P	Q	R	S	T	U
350	20	50	38	10	25	21	50	22	20	6	13	12	44	29	110	75	305	40	50
800	20	50	38	10	25	2	50	22	20	6	13	12	62	32	146	75	381	40	50
2000	32	35	85	25	30	26	50	25	20	10	12	16	85	32	197	102	457	45	56
3600				20	127	32	65	44							286			105	128
8000				20	203	32	65	44							436			105	128

## CHOICE OF GEARS

Guide Channels



Brackets - Face Fixed

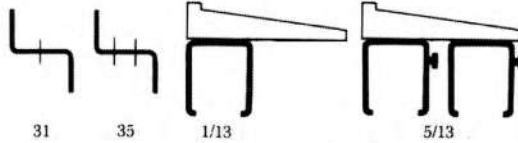

Brackets - Soffit Fixed



Top Guides

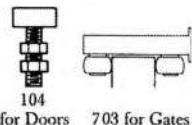

Bottom Rollers for Metal Doors

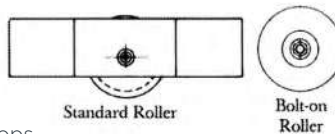

Accessories

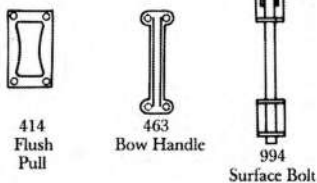

Door Stops

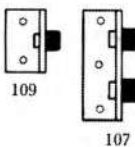

Bottom Rails

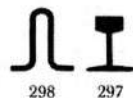

## EXAMPLE PLAN DETAILS

Single Run

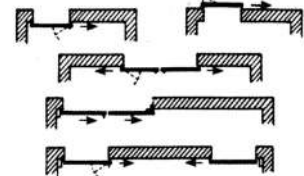

Double Run

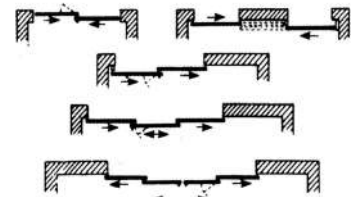

Accessories

**View our full range of door handles and flush pulls on pages 128 and 129.**

# OVERHEAD RUNWAY

Selection of track, curves and brackets which can be used together to make a variety of overhead runway systems



P C Henderson's tracks, curves and brackets can be used together with a choice of specially adapted hangers to make a variety of overhead runway systems. Suitable for a wide variety of applications including curtains, cable carriers, safety runways for use in factories, warehouses, dairies, commercial and public buildings and vehicles.

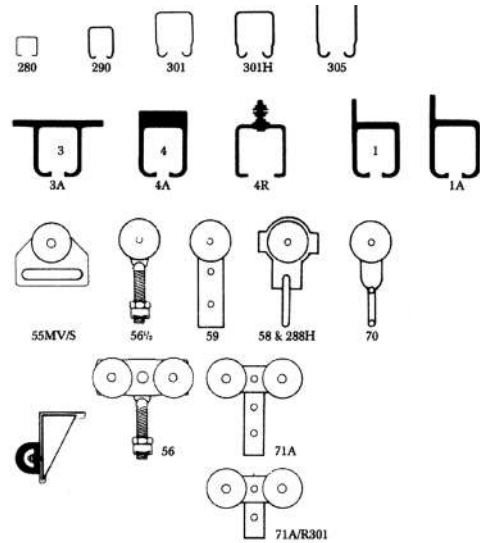





# Folding Doors



Catering for maximum door weights of between 14kg and 150kg, our range of folding door hardware can cater for interior and exterior applications, end fold and centre fold mechanisms as well having the ability to hold virtually any number of doors in a variety of combinations.

Whether it be for a bi-folding cupboard, a versatile room divider or a stylish exterior system to open up a home to the outside world – P C Henderson has a folding door solution for every project.

When used internally, as room dividers and partitions, folding doors are the perfect way to create flexible living and working environments allowing an entire room to be opened up at ease. When used externally, folding doors can create a truly wonderful indoor/outdoor environment, making the most of natural light and external views.

## Range Overview

- Over 15 different systems
- Catering for maximum door weights of between 14kg and 150kg
- Suitable for wooden, metal or glass doors
- Interior and exterior applications

[www.pchenderson.com](http://www.pchenderson.com)



# BIFOLD

For folding wardrobe and cupboard doors weighing up to 14kg



The Bifold range of folding door hardware offers a stable, silent and smooth-opening folding system for cupboard and wardrobe doors that can complement any room. Designed for wooden, wood framed or composite doors, the Bifold system can support a maximum door weight of 14kg and door thickness of between 18-35mm. A range of kits are available up to a maximum opening width of 2134mm. A fittings kit is available for when an additional door is required.

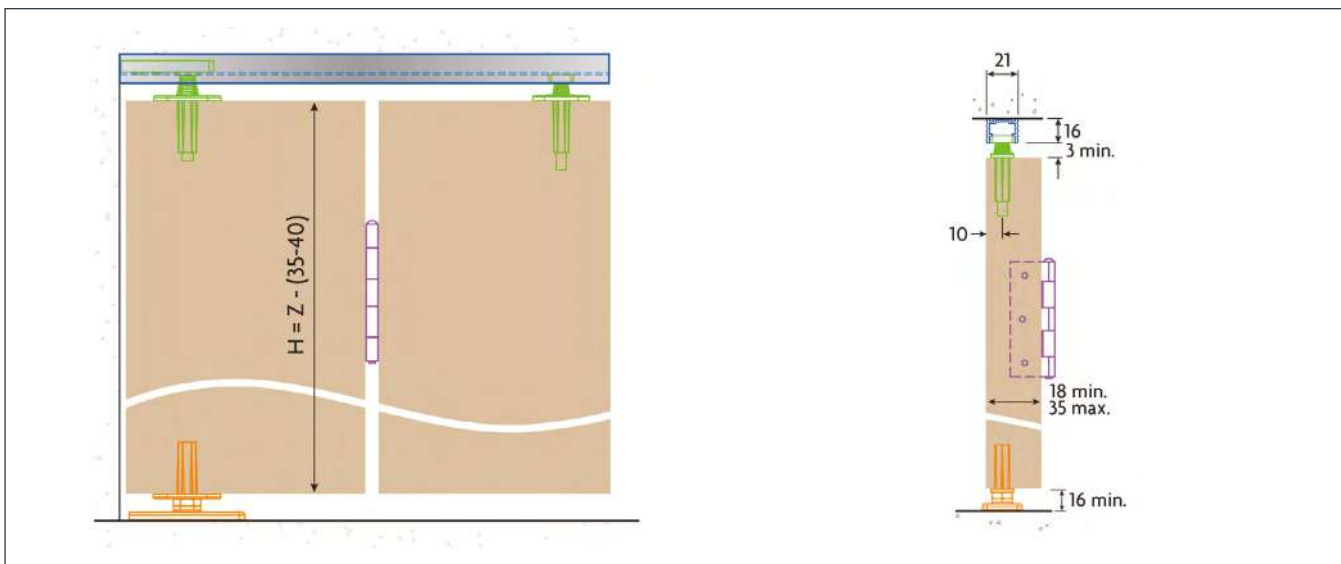

### Product Information

Kit Order Code	No. of Doors	Track Length	Max. Door Height	Max. Door Width	Door Thickness Range	Max. Door Weight
B10/2	2	1067mm	2400mm	530mm	18 - 35mm	14kg
B15/4	4 (2+2)	1524mm	2400mm	530mm	18 - 35mm	14kg
B20/4	4 (2+2)	2134mm	2400mm	530mm	18 - 35mm	14kg
BF2	Fittings Kit for when an additional door is required					

### Kit Contents

Component	Short Code
Track (x 1 for 2 doors, x 2 for 4 doors)	310/****
Top Pivot Socket (x 1 for 2 doors, x 2 for 4 doors)	311
Top Pivot (x 1 for 2 doors, x 2 for 4 doors)	313
Nylon Guide (x 1 for 2 doors, x 2 for 4 doors)	315
Hinges (x 3 for 2 doors, x 6 for 4 doors)	282S
Adjustable Bottom Pivot Assembly (x 1 for 2 doors, x 2 for 4 doors)	289B

\*\*\*\* replace by length of track for full short code

### Accessories



View our full range of door handles and flush pulls on pages 128 and 129.

1 Door Fittings Kit (BF2)



# ROOMFLEX

Minimalistic folding door solution with no bottom channel for doors weighing up to 35kg and 50kg



Roomflex is an innovative, internal folding door system that has been designed to create and enhance flexible living environments. Unlike other internal folding door systems, Roomflex has been designed to completely eliminate the need for a bottom channel, allowing for an aesthetically pleasing, seamless walkway from room to room.

Homeowners can combine both open and broken-plan living by neatly storing the doors when the spaces are opened for entertaining or socialising. When closed, the smaller rooms can be used for independent activities such as reading or catching up on TV shows or to simply reduce the space to what is necessary at varying times.

## Product Information

Kit Order Code	Door Configuration	Max. Door Height	Max. Door Width	Door Thickness Range	Max. Door Weight
RFK1	2	3000mm	926mm	35 - 44mm	35kg
RFK2	3	3000mm	926mm	35 - 44mm	35kg
RFK3	3+1	3000mm	926mm	35 - 44mm	35kg
RF50K1	2	3000mm	926mm	35 - 44mm	50kg
RF50K2	3	3000mm	926mm	35 - 44mm	50kg
RF50K3	3+1	3000mm	926mm	35 - 44mm	50kg
RFK4	Swing door	3000mm	926mm	35 - 44mm	35kg/50kg

## Kit Contents

Product	Component
RFK1 and RF50K1	Pivot Set (x 1)
	Hinge Handle Set (x 1)
	End Hanger Set (x 1)
	110mm Flush Bolt (x 1) (FB110S)
RFK2 and RF50K2	Pivot Set (x 1)
	Offset Handle Hinge Set (x 1)
	Intermediate Hanger Set (x 1)
	110mm Flush Bolt (x 2) (FB110S)
RFK3 and RF50K3	Pivot Set (x 2)
	Offset Handle Hinge Set (x 1)
	Intermediate Hanger Set (x 1)
	110mm Flush Bolt (x 2) (FB110S)
RFK4	Pivot Set (x 1)

## Track Specification

Track must be purchased in addition to kit

Short Code	Description
180/****	Anodised aluminium track available in 2000, 2500, 3000, 3500, 4000, 5000 and 6000mm lengths

\*\*\*\* replace by length of track for full short code

## Accessories



Door Perimeter Seal in Brown (**AQ63B**)



Frame Perimeter Seal in Brown (**AQ21B**)



Track Seal in Black (**BS10B**)

**View our full range of door handles and flush pulls on pages 128 and 129.**

# HUSKY FOLDING

For folding interior doors weighing up to 25kg and 40kg



Husky folding door hardware provides a simple and flexible solution for both light and medium weight residential folding partitions. Designed for wooden, wood framed and composite doors, its concealed fixings and robust floor gear allow the partitions to be neatly stacked to one or both sides. The Husky Folding 25 can support doors weighing up to 25kg and 610mm wide without a floor channel, and the Husky Folding 40 can support doors weighing up to 40kg and 762mm wide, with a floor channel guide included. The track can be cut to length and extra pivots are required for two doors folding each way.

## Product Information

Product	Kit Order Code	No. of Doors	Track Length	Max. Door Height	Max. Door Width	Door Thickness Range	Max. Door Weight	
Husky 25	HF25/12	2	1234mm	2400mm	610mm	20 - 44mm	25g	
	HF25/24	4	2458mm	2400mm	610mm	20 - 44mm	25kg	
	HF2/25	Fittings kit to be used when an additional 2 doors are required						25kg
	HF4/25	Fittings kit to be used when an additional 4 doors are required						25kg
Husky 40	HF40/15	2	1538mm	2700mm	762mm	20 - 44mm	40kg	
	HF40/30	4	3066mm	2700mm	762mm	20 - 44mm	40kg	
	HF2/40	Fittings Kit to be used when an additional 2 doors are required						40kg
	HF4/40	Fittings Kit to be used when an additional 4 doors are required						40kg

## Kit Contents

	Component	Short Code
Husky 25	Steel Track (x 1)	280/****
	Top Pivot - for fixing onto end panel (x 1)	289T
	Bottom Pivot - for fixing onto end panel (x 1)	289B
	Four Wheeled Adjustable Nylon Hangers (x 1 for 2 doors/x 2 for 4 doors)	283N
	Hinges (x 3 for 2 doors/x 9 for 4 doors)	282/S
Husky 40	Steel Track (x 1)	280/****
	Top Pivot - for fixing onto end panel (x 1)	289T
	Bottom Pivot - for fixing onto end panel (x 1)	289B
	Guide Channel (x 1)	94X/****
	Needle Roller Bearing Hangers - (x 1 for 2 doors/ x 2 for 4 doors)	283
	Roller Guide (x 1 for 2 doors/x 2 for 4 doors)	106HF/94
	Hinges (x 3 for 2 doors/x 9 for 4 doors)	282/S

\*\*\*\* replace by length of track for full short code

Note: Extra pivots required for 4 doors folding (2+2) (289B & 289T)

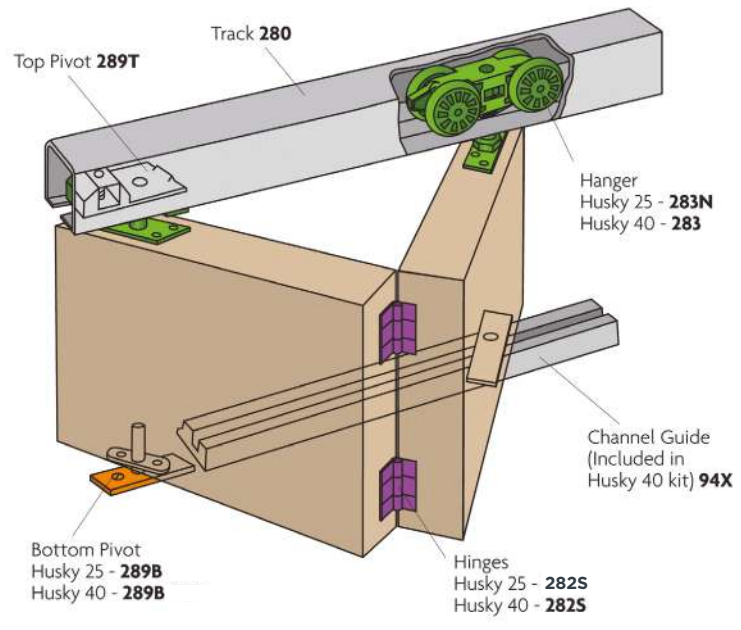

Husky 25

Husky 40

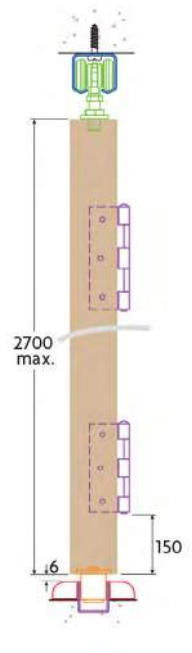
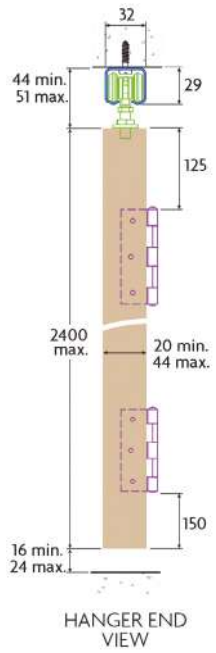
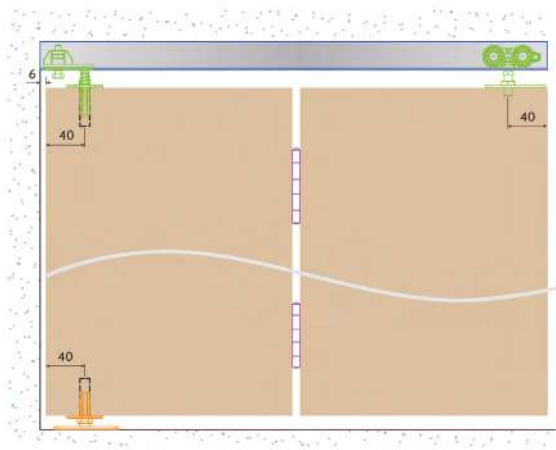
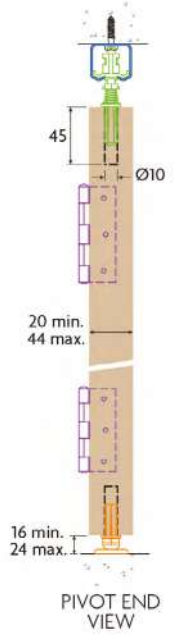

Accessories



2 Door Fittings Kit for Husky 25 (HF2/25)



2 Door Fitting Kit for Husky 40 (HF2/40)



4 Door Fittings Kit for Husky 25 (HF4/25)



4 Door Fittings Kit for Husky 40 (HF4/40)

View our full range of door handles and flush pulls on pages 128 and 129.



# PACER ENDFOLD

For interior folding doors weighing up to 35kg and 65kg



Pacer Endfold is a top hung, medium weight partition door system that is perfect for internal residential and commercial applications requiring end folding doors. The system offers both two-wheeled and four-wheeled hangers to cover a wide range of applications. Panels can be hung to the left or the right of an opening, or hung as floating units. In applications using the four-wheeled hanger with an even number of panels folding left and right meeting in the centre of an opening, an offset hanger (21BO/4) is required.

## Product Information

Product	Max. Door Height	Max. Door Width	Door Thickness Range	Max. Door Weight
Pacer Endfold	2700mm	900mm	35 - 44mm	35kg or 65kg*

\*35kg if using 21B hanger

## Product Specification

Component	Door Configuration	Short Code
Track	Aluminium mill finish track in 2000, 2500, 3000, 3500, 4000 and 6000mm lengths	600/****
	Anodised aluminium track in 2000, 2500, 3000, 3500, 4000 and 6000mm lengths	600/****AN
Brackets	Face fixed bracket (fixed at 500mm intervals)	1B
	Joining bracket	1BX
Hangers Offset hanger required in applications with an even number of doors folding left and right meeting in the centre of an opening.	Two-wheeled end hanger (max. door weight of 35kg)	21B
	Four-wheeled end hanger	21B/4
	Four-wheeled offset end hanger	21BO/4
Pivots For door widths of between 35 - 44mm. Allows doors to be of equal width.	Pivot	21B/P
Guides 1 every 2 door leaves	Nylon end guide roller	21N/94
Guide Channel	Brass guide channel, same lengths as track	94/****
	Aluminium guide channel, same lengths as track	94X/****
	Aluminium threshold guide channel, same lengths as track	94T/****
Hinges	Butt hinge - 100 x 55mm	403/2

\*\*\*\* replace by length of track for full short code

## Accessories



Satin anodised aluminium flush bolt (333)



Non locking flush bolt (FB110S)

**View our full range of door handles and flush pulls on pages 128 and 129.**

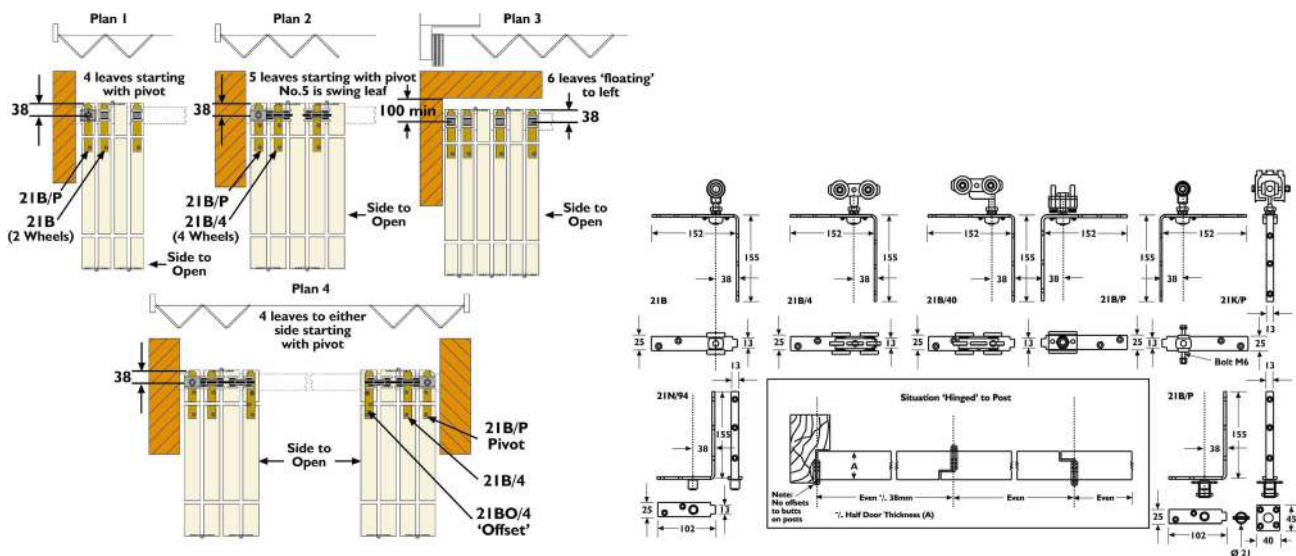
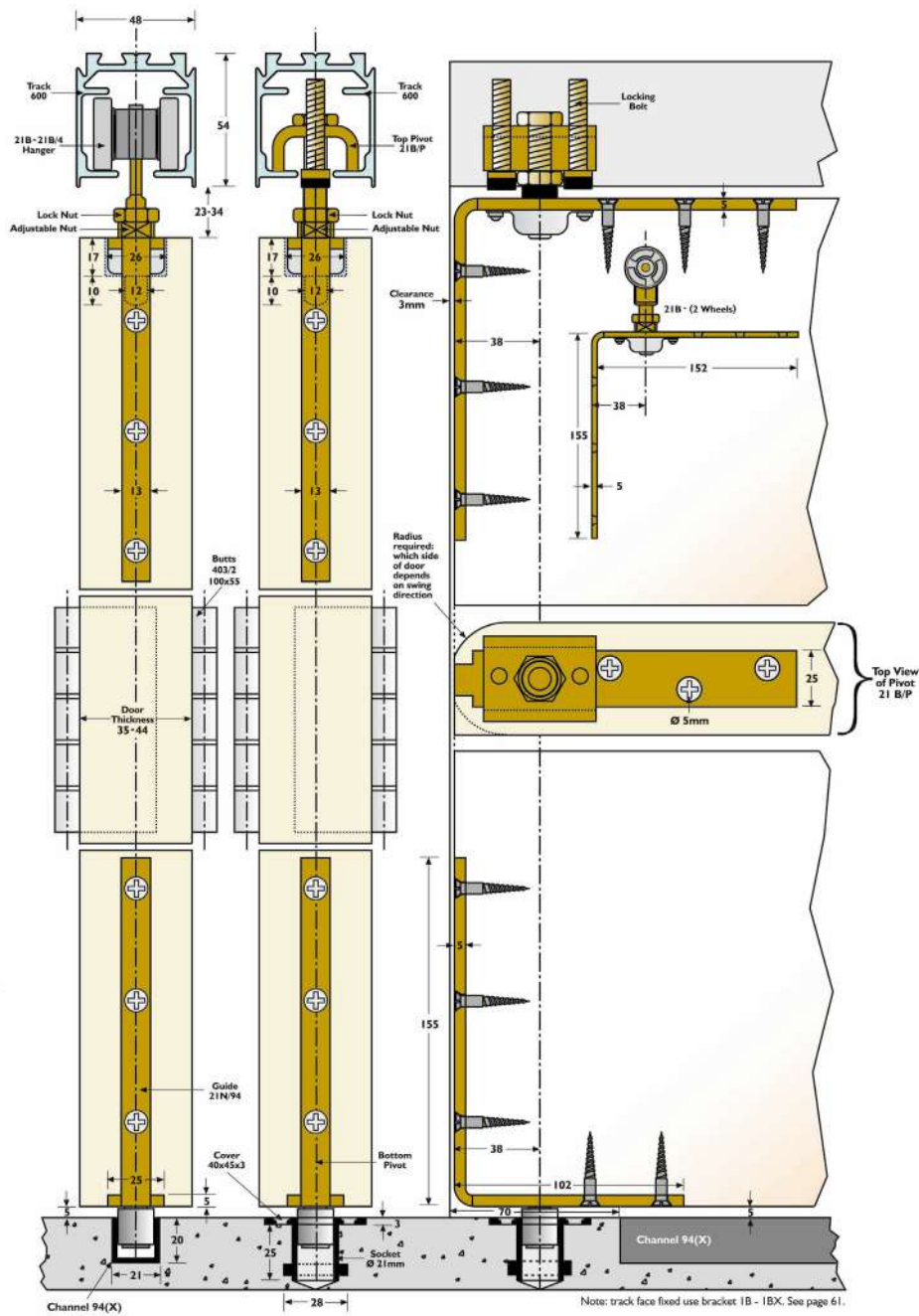

# TANGENT FOLDING

For top hung folding wooden or metal doors weighing up to 35kg, 55kg and 70kg



Tangent Folding is a range of robust, top-hung hardware systems for commercial or light industrial applications. The system is suitable for panelled, flush or glazed doors with a range of three systems to suit door weights of up to 70kg. Doors can fold to one or both sides or can also be stacked behind a reveal if required. The system covers any width of opening and so any number of folding doors can be used. Floating units should consist of an even number of doors in units of four, six or eight.

Folding units of up to eight doors can be hinged to post or free-floating. A swinging access door can be included within a unit hinged to post incorporating an odd number of panels. Alternatively, an access door can be independently hinged to post.

Floating units should always consist of an even number of panels in units of four, six or eight. Clearance between leaves to be 2mm minimum. Doors can be constructed to provide secure fixing for hangers, hinges and guides and can either be flush, panelled or glazed.

## Product Information

Product	Max. Door Height	Max. Door Width	Door Thickness Range	Max. Door Weight
Tangent 290	2400mm	900mm	35 - 50mm	35kg
Tangent 301	3300mm	900mm	45 - 55mm	55kg
Tangent 301H	3600mm	900mm	45 - 55mm	70kg

## Product Specification

Component	Door Configuration	Tangent 290 Short Code	Tangent 301 Short Code	Tangent 301H Short Code
Track Equal to width of opening (extra if doors slide further)	Galvanised steel track in 2000, 2500, 3000, 4000 and 6000mm lengths.	290/****	301/****	301H/****
Brackets Fix every 900mm max and at track joints. Fix additional brackets where doors stack	Face fixed bracket	1A/290	1A/301	1A/301
	Soffit fixed bracket	3A/290	3A/301	3A/301
Hangers 1 every 2 doors	Intermediate hanger	62K	62A	62A
	End hanger	63K	63A	63A
Hinges 3 in height. Extend to 4 when doors exceed 300mm high.	Aluminium alloy backflap hinge	65	65	65
Guides 1 every 2 door leaves	Intermediate guide	67/89	67/97	67/97
	End guide	68/89	68/97	68/97
Channels Same length as track	Galvanised steel channel in 2000, 2500, 3000, 4000 and 6000mm lengths.	89/****	97/****	97/****

\*\*\*\* replace by length of track for full short code

SECTION DETAILS

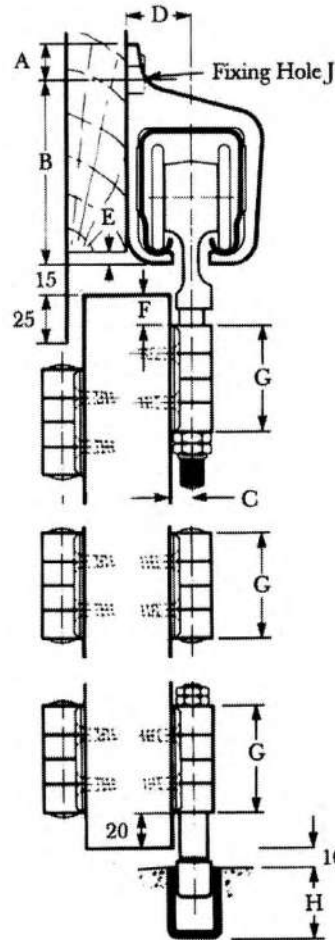

EXAMPLE PLAN DETAILS

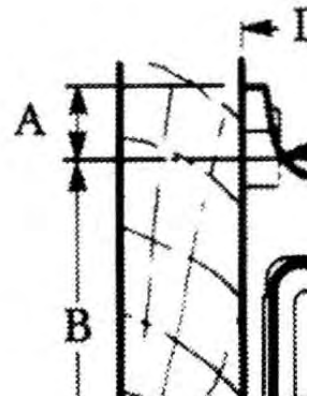

CHOICE OF GEARS

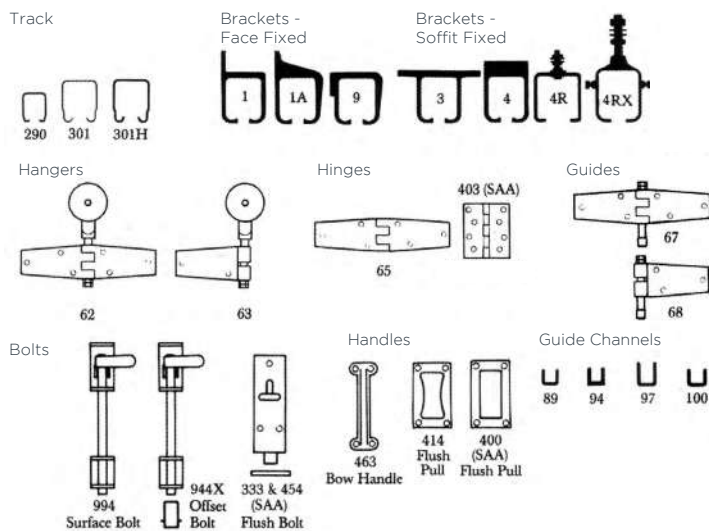

Dimensions									
Track	A	B	C	D	E	F	G	H	J
290	13	67	11	27	6	10	57	25	M8
301/301H	20	97	11	35	6	15	57	38	M12

Accessories



Cast Iron Bow Handle 159 x 46mm (**463**)



Galvanised Steel Shoot Bolt 380mm (**994**)

View our full range of door handles and flush pulls on pages 128 and 129.



# PACER CENTREFOLD

For top hung centre folding interior partition doors weighing up to 35kg and 75kg



Pacer Centrefold is a top hung system for centre folding wooden partition doors. Doors are hung centrally and can fold to one or both sides. For applications hinged to the jamb, 3.5, 5.5 or 7.5 doors can be used with the half door hinged to the jamb. For best operation of floating units 5, 7 or 9 doors should be used. Any access doors should be hinged separately to the jamb.

## Product Information

Product	Max. Door Height	Max. Door Width	Door Thickness Range	Max. Door Weight
Pacer Centrefold	2700mm	900mm	35 - 44mm	35kg or 75kg*

\*35kg if using 61B hanger

## Product Specification

Component	Description	Short Code
Track	Aluminium mill finish track available in 2000, 2500, 3000, 3500, 4000, 6000mm lengths	600/****
	Anodised aluminium track in 2000, 2500, 3000, 3500, 4000, 6000mm lengths	600/****AN
Brackets	Face fixed bracket (fixed at 500mm intervals)	1B
	Joining bracket	1BX
Hangers	Two-wheeled end hanger (max. door weight of 35kg)	61B
	Four-wheeled end hanger (max. door weight of 75kg)	61B/4
Guides	Nylon guide roller	106N/94
Guide Channel	Brass guide channel available in 1500 and 3000mm lengths	94/****
	Aluminium guide channel available in 1500, 2000, 2500 and 3000mm lengths	94X/****
	Aluminium threshold guide channel available in 2000, 2500, 3000, 3500, 4000 and 6000mm lengths	94T/****
Hinges	Butt Hinge - 100 x 55mm	403/2

\*\*\*\* replace by length of track for full short code

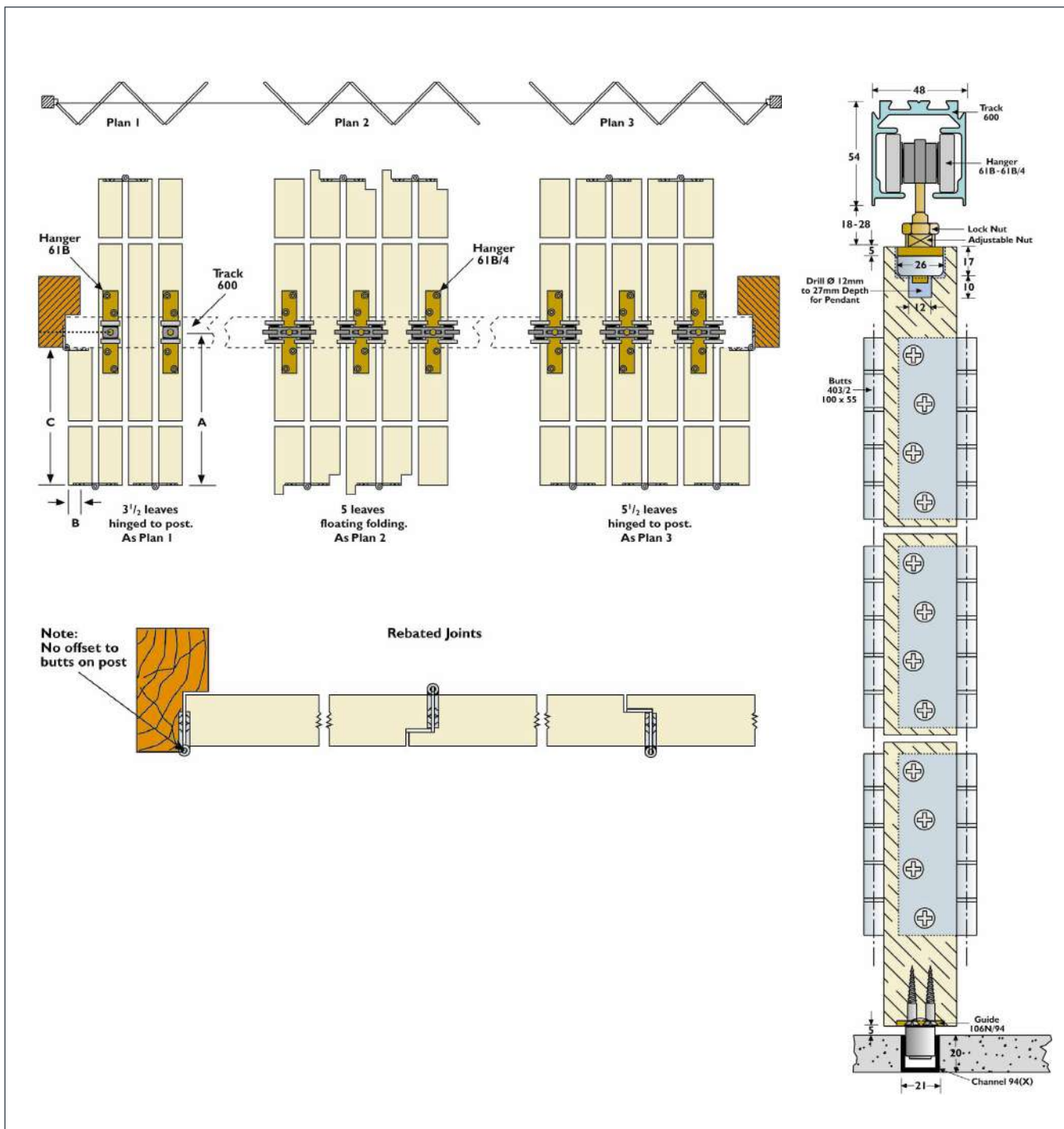

Accessories



Satin Anodised Aluminium Flush Bolt (333)



Non Locking Flush Bolt (FB110S)

View our full range of door handles and flush pulls on pages 128 and 129.

# SOLTAIRE ENDFOLD

For metal or wooden end folding doors weighing up to 45kg and 75kg



Catering for folding doors weighing up to 45kg or 75kg, Soltaire Endfold is the ideal solution for partition doors in residential or commercial applications. Manufactured from 316 marine grade stainless steel, the system is extremely durable and hard wearing, utilising components from our popular Securefold and Soltaire products. The system is particularly suitable for partitions where all doors are of equal width.

The folding unit is pivoted in the track and off the floor - allowing adjustment on all doors. Doors can fold to one or both sides of the opening as well as being able to cater for multiple combinations to cover any width of opening. End folding units of up to eight doors can be pivoted to provide each side of the opening.

## Product Information

Kit Order Code	Door Configuration	Max. Door Height	Max. Door Width	Door Thickness Range	Max. Door Weight
SEF145	2 Door Base Kit	3000mm	900mm	35 - 44mm	45kg
SEF245	2 Door Add-On Kit	3000mm	900mm	35 - 44mm	45kg
SEF175	2 Door Base Kit	3300mm	900mm	35 - 44mm	75kg
SEF275	2 Door Add-On Kit	3300mm	900mm	35 - 44mm	75kg
SF5S	1 Door Add-On Kit	3300mm	900mm	35 - 44mm	45kg/75kg
SEFP	Swing Door	3300mm	900mm	35 - 44mm	45kg/75kg

## Track and Channel Specification

Track and channel must be purchased in addition to kit

45kg System Short Code	75kg System Short Code	Description
180/****	250/****	Anodised aluminium track available in 3000, 4000, 5000 and 6000mm lengths
94P/****	94P/****	Polypropylene channel in black available in 3000, 4000, 5000 and 6000mm lengths
94SC/****	94SC/****	Support channel for polypropylene channel available in 3000, 4000, 5000 and 6000mm lengths

## Kit Contents

Product	Component
SEF145 and SEF175	Pivot Set (x1)
	Hinge Handle Set (x1)
	End Hanger and Guide Set (x1)
	110mm Flush Bolt (x1) (FB110S)
SEF245 and SEF275	Midset Hinge Set (x1)
	Hinge Handle Set (x 1)
	End Hanger and Guide Set (x1)
	110mm Flush Bolt (x1) (FB110S)
SF5S	Midset Hinge Set (x1)
SEFP	Pivot Set (x1)

\*\*\*\* replace by length of track for full short code

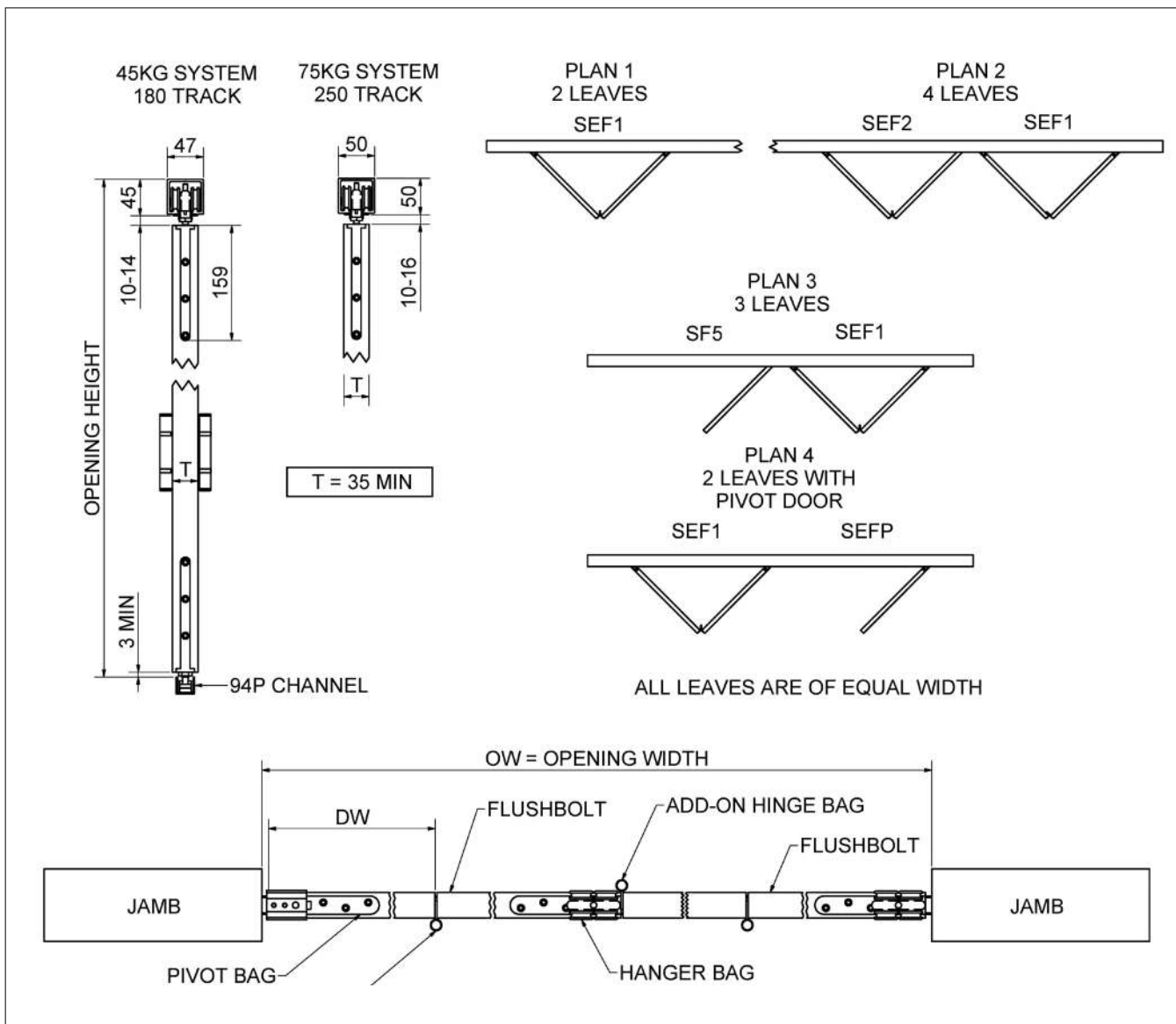

Accessories

[View our full range of door handles and flush pulls on pages 128 and 129.](#)



# SOLTAIRE CENTREFOLD

For metal or wooden centre folding doors weighing up to 45kg and 75kg



Catering for folding doors weighing up to 45kg and 75kg, Soltaire Centrefold is the ideal solution for partition doors in residential and commercial applications. Manufactured from 316 marine grade stainless steel, the system is extremely durable and hard wearing, utilising components from our popular Securefold and Soltaire products. The system is also particularly suitable for applications where increased height is a requirement.

As a centre folding system, the weight of the doors is supported centrally under the track. Panels can be floating or fold to one or both sides of the opening as well as being able to cater for multiple combinations of folding panels to cover any width of opening. For best operation - one, three, five or seven panels should be used.

## Product Information

Kit Order Code	Door Configuration	Max. Door Height	Max. Door Width	Door Thickness Range	Max. Door Weight
SCF145	1.5 Door Base Kit	3000mm	900mm	35 - 44mm	45kg
SCF245	2 Door Add-On Kit	3000mm	900mm	35 - 44mm	45kg
SCF175	1.5 Door Base Kit	3300mm	900mm	35 - 44mm	75kg
SCF275	2 Door Add-On Kit	3300mm	900mm	35 - 44mm	75kg
SF5S	1 Door Add-On Kit	3300mm	900mm	35 - 44mm	45kg/75kg

## Track Specification Track must be purchased in addition to kit

45kg System Short Code	75kg System Short Code	Description
180/****	250/****	Anodised aluminium track available in 3000, 4000, 5000 and 6000mm lengths
94P/****	94P/****	Polypropylene channel in black available in 3000, 4000, 5000 and 6000mm lengths
94SC/****	94SC/****	Support channel for polpropylene channel available in 3000, 4000, 5000 and 6000mm lengths

## Kit Content

Product	Component
SCF145 and SCF175	Pivot Set (x1)
	Hinge Handle Set (x1)
	Centrefold Hanger and Guide Set (x1)
	110mm Flushbolt (x1) (FB110S)
SCF245 and SCF275	Midset Hinge Set (x1)
	Hinge Handle Set (x1)
	Centrefold Hanger and Guide Set (x1)
	110mm Flush Bolt (x1) (FB110S)
SF5S	Hinge Set

\*\*\*\* replace by length of track for full short code

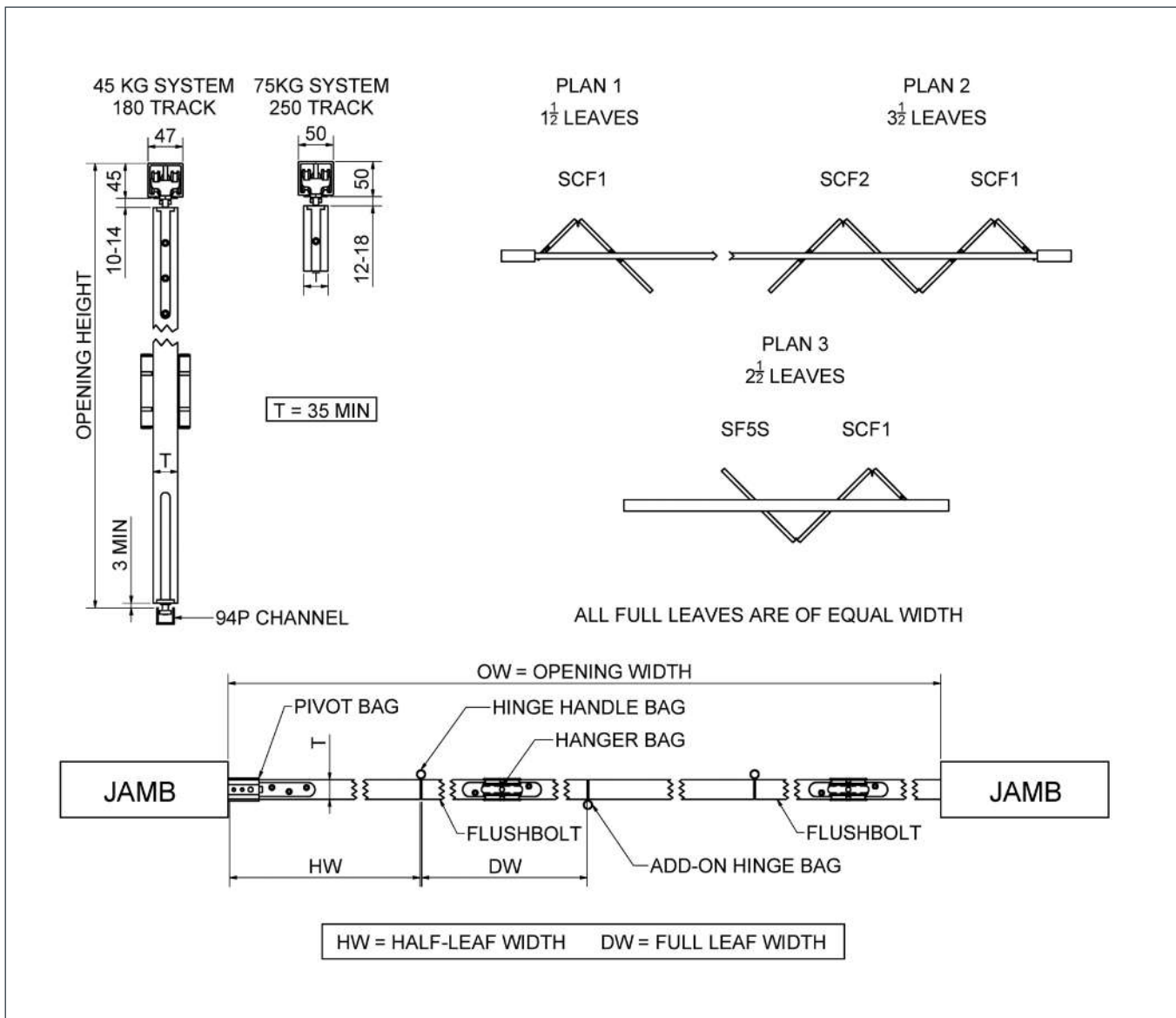

Accessories

[View our full range of door handles and flush pulls on pages 128 and 129.](#)

# SECUREFOLD BOTTOM ROLLING

Bottom rolling system for folding wooden doors weighing up to 80kg



Our latest addition to the Securefold family allows for huge flexibility in terms of the type of applications it can cater for. Utilising bottom rolling technology, the product carries the load of the doors at the bottom of the system eliminating the need for a large upper beam. This allows doors to be installed into virtually any space without the need for major structural building support. It also frees up design space allowing for a much more minimalistic look. Typical applications include orangeries, conservatories, out buildings and extensions

### Securefold Specifier

Use our online Securefold Specifier tool to quickly build a bill of materials or get a quotation [www.pchenderson.com/securefold-specifier](http://www.pchenderson.com/securefold-specifier)

### Product Information

Product	Max. Door Height	Max. Door Width	Door Thickness Range	Max. Door Weight
Securefold Bottom Rolling	3000mm	1000mm	56 - 68mm	80kg

### Product Specification

Component	Description	Short Code
Track	Anodised aluminium track available in 3000, 4000 and 6000mm lengths	242/****
Pivot	Pivot assembly	SFBR1#
Roller	End roller set kit	SFBR2#
	Intermediate roller set kit	SFBR4#
Hinge	Hinge handle set	SF3#
	Hinge set - offset outward opening	SF7#
	Intermediate hinge for doors above 2200mm	SF9#
Meeting Kit	Meeting kit	SFBR8#
Channel	Polypropylene guide channel available in 3000, 4000 & 6000mm lengths	94P/****
	Anodised aluminium support channel available in 3000, 4000 & 6000mm lengths	94SC/****
Seals	Door perimeter seal in brown	AQ63B
	Frame perimeter seal in brown	AQ21B
	Track seal in black	BS10B
Flushbolts	Non lockable flushbolt in 190, 450 and 600mm lengths	SF190#/SF450#/SF600#
	Lockable flush bolt in 190, 450 and 600mm lengths	SF190L#/SF450L#/SF600L#

\*\*\*\* replace by length of track for full short code

# replace with first letter of required colour for full short code - available in gold, black, chrome or satin

Hinge options include standard (SFBR) non-morticed (SFWBR), radius morticed (SFRBR) and square morticed (SFMBR), see page 96 for details.

## Door Configurations and Hardware Quantities

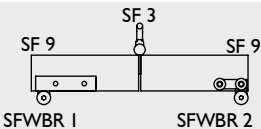
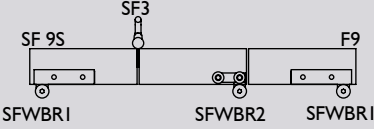
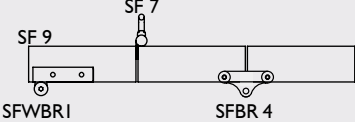
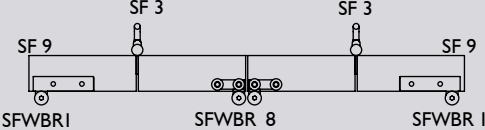
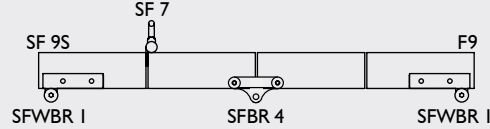
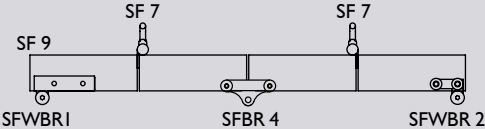
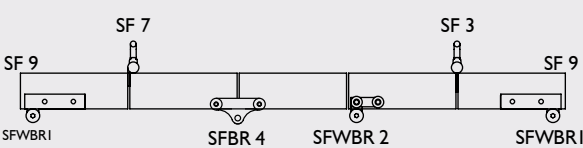
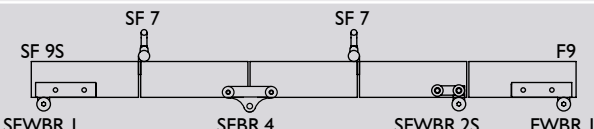
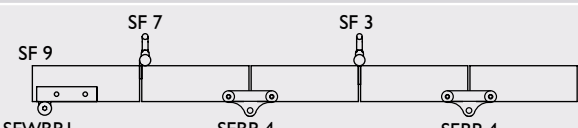
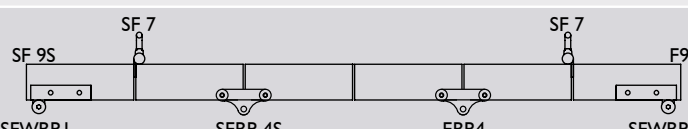
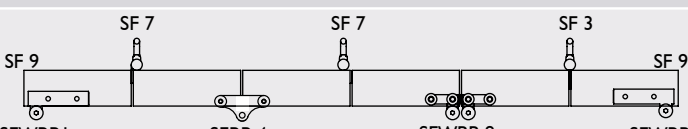
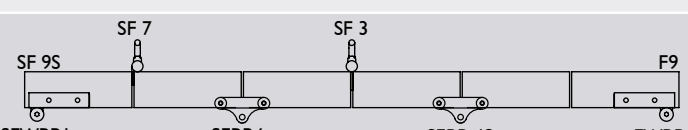
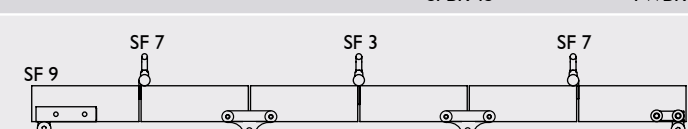
Door Configuration		Hardware
<b>2 Leaf</b>		SFBR1 x 1 SF3 x 1 SFBR2 x 1 SF9 x 1 SF Flushbolt x 2
<b>2 + 1 Leaf</b>		SFBR1 X 2 SF3 X 1 SFBR2 X 1 SF9 X 2 SF Flushbolt x 2
<b>3 Leaf</b>		SFBR x 1 SF7 x 1 SFBR4 x 1 SF9 x 1 SF Flushbolt x 2
<b>2 + 2 Leaf</b>		SFBR1 x 2 SF3 x 2 SFBR8 x 1 SF9 x 2 SF Flushbolt x 4
<b>3 + 1 Leaf</b>		SFBR1 x 2 SF7 x 1 SFBR4 x 2 SF9 x 2 SF Flushbolt x 4
<b>4 Leaf</b>		SFBR x 1 SF7 x 2 SFBR4 x 1 SFBR2 x 1 SF9 x 1 SF Flushbolt x 4
<b>3 + 2 Leaf</b>		SFBR1 x 2 SF7 x 1 SF3 x 1 SFBR2 x 1 SFBR4 x 1 SF9 x 2 SF Flushbolt x 4
<b>4 + 1 Leaf</b>		SFBR1 x 2 SF7 x 2 SFBR4 x 1 SFBR2 x 1 SF9 x 2 SF Flushbolt x 4
<b>5 Leaf</b>		SFBR1 x 1 SF7 x 1 SF3 x 1 SFBR4 x 2 SF9 x 1 SF Flushbolt x 4
<b>3 + 3 Leaf</b>		SFBR1 x 2 SF7 x 2 SFBR4 x 2 SF9 x 2 SF Flushbolt x 6
<b>4 + 2 Leaf</b>		SFBR1 x 2 SF7 x 2 SF3 x 1 SFBR8 x 1 SF9 x 2 SF Flushbolt x 6
<b>5 + 1 Leaf</b>		SFBR1 x 2 SF7 x 1 SF3 x 1 SFBR4 x 2 SF9 x 2 SF Flushbolt x 6
<b>6 Leaf</b>		SFBR1 x 1 SF7 x 2 SFBR4 x 2 SF3 x 1 SFBR2 x 1 SF9 x 1 SF Flushbolt x 6



# SECUREFOLD BOTTOM ROLLING CONTINUED



Choose from a choice of four stunning finishes - gold, chrome, black or satin

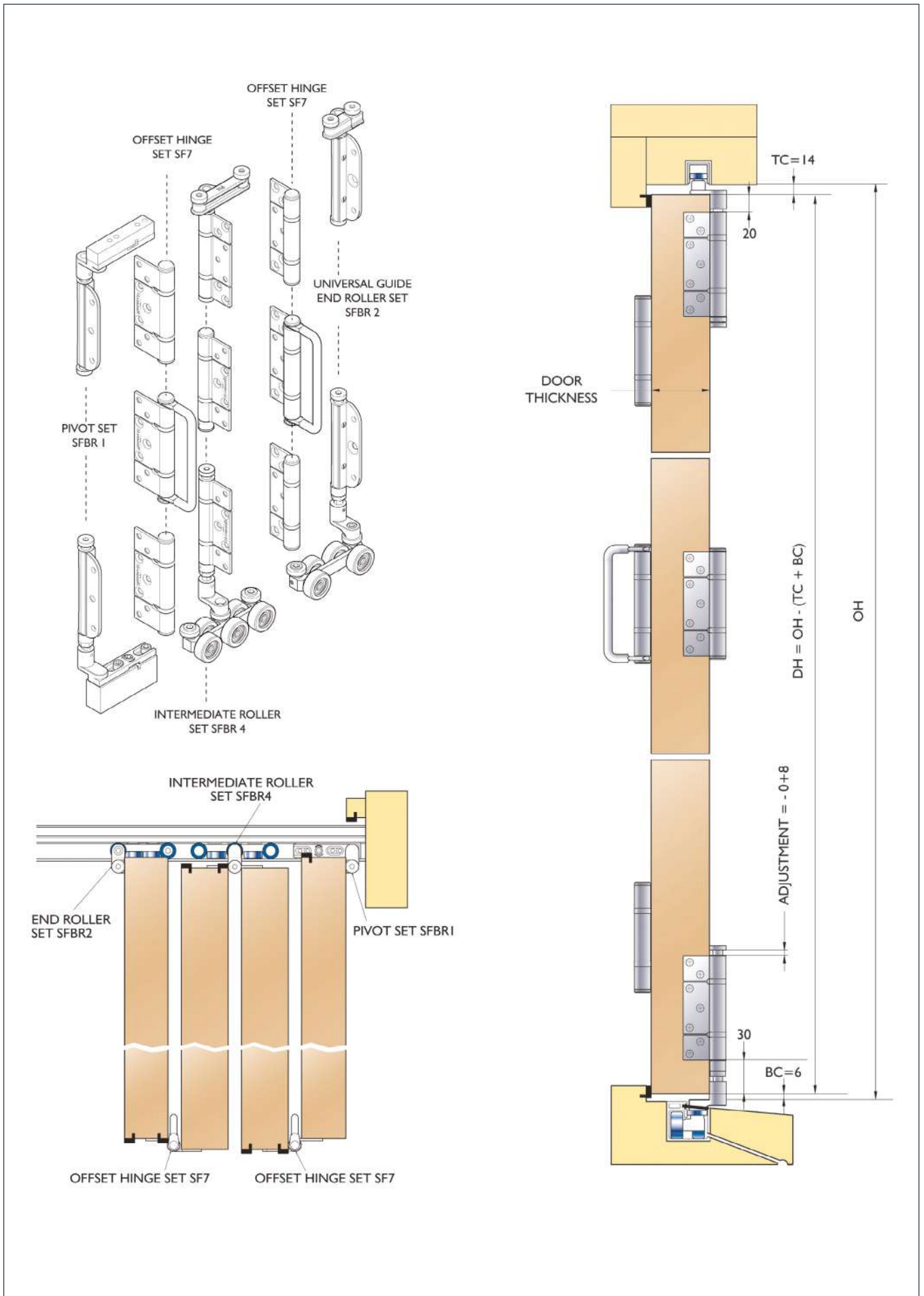

Accessories [View our full range of door handles and flush pulls on pages 128 and 129.](#)

# COUNCIL CENTREFOLD

For centre folding wooden partition doors weighing up to 35kg, 55kg, 70kg or 80kg



Council Centrefold offers a quality top hung system designed for centre folding wooden partition doors with four systems available catering for a maximum door weight of 80kg. Folding units of up to seven full doors and one half door can be hinged to the post. When using floating units, configurations must consist of five, seven or nine full doors and have a minimum clearance of 2mm between them.

Council Centrefold offers the opportunity to house access doors in the form of a swing door or a wicket door contained in one of the doors. It is essential that all doors are of equal width, it is also worth noting that door leaves should be constructed to provide secure fixing for hanger, hinges and guides and can be flush, panelled or glazed.

## Product Information

Product	Max. Door Height	Max. Door Width	Door Thickness Range	Max. Door Weight
Council Centrefold 290	2700mm	1000mm	35 - 44mm	35kg
Council Centrefold 301	3300mm	1000mm	44 - 57mm	55kg
Council Centrefold 301H	3600mm	1000mm	44 - 57mm	70kg
Council Centrefold 305	4500mm	1000mm	44 - 57mm	80kg

## Product Specification

Component	Description	Council Centrefold 290 Short Code	Council Centrefold 301 Short Code	Council Centrefold 301H Short Code	Council Centrefold 305 Short Code
Track Equal to opening width	Galvanised steel track, available in 2000, 2500, 3000, 4000 and 6000mm lengths	290/****	301/****	301H/****	305/****
Brackets Fix every 900mm max and at track joints. Fix extra bracket where doors stack.	Soffit fixed bracket	3A/290	3A/301	3A/301	3A/305
Hangers 1 every 2 leaves	Centre folding hanger, steel wheels Centre folding hanger, nylon wheels	61K/S 61K/N	61A/S -	61A/S -	61C/S -
Hinges 3 in height. Increase to 4 for doors over 3000mm high	Butt hinge	403/1	403/2	403/2	403/3
Guides 1 every 2 leaves	Centre folding guide	106R/94	106R/94	106R/94	106R/94
Guide Channel	Brass guide channel available in 1500 and 3000mm lengths	94/****	94/****	94/****	94/****
	Aluminium guide channel available in 1500, 2000, 2500 and 3000mm lengths.	94X/****	94X/****	94X/****	94X/****

\*\*\*\* replace by length of track for full short code

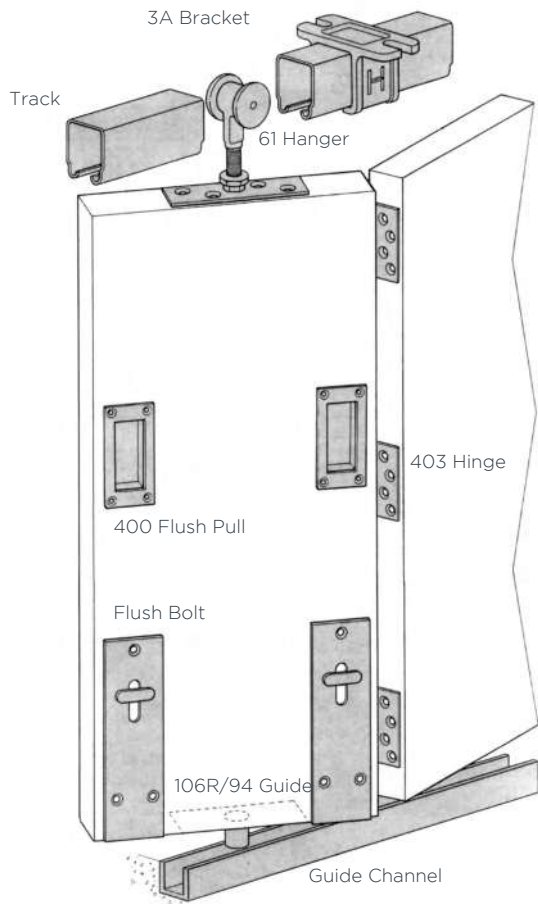

**SECTION DETAILS**

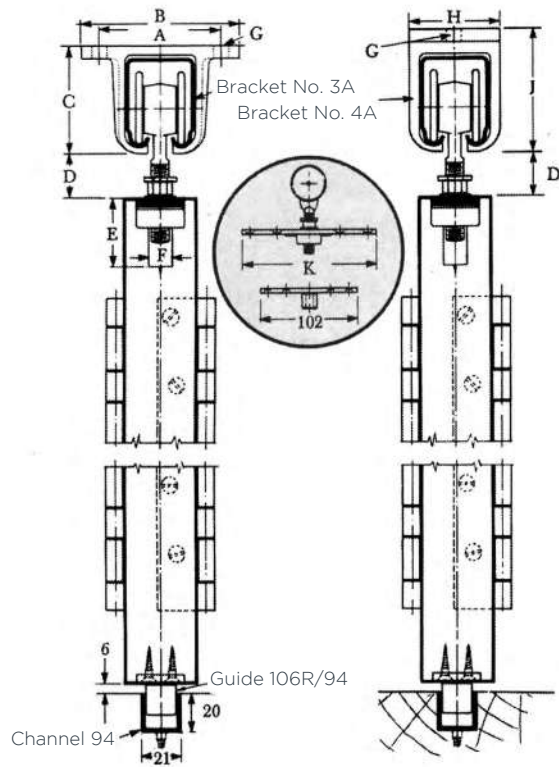

**Dimensions**

Track	A	B	C	D	E	F	G	H	J	K
290	64	83	56	23	38	13	M8	48	67	140
301/301H	100	130	86	45	50	20	M12	75	95	184
305	125	168	12	60	65	20	M16	83	137	241

**CHOICE OF GEARS**

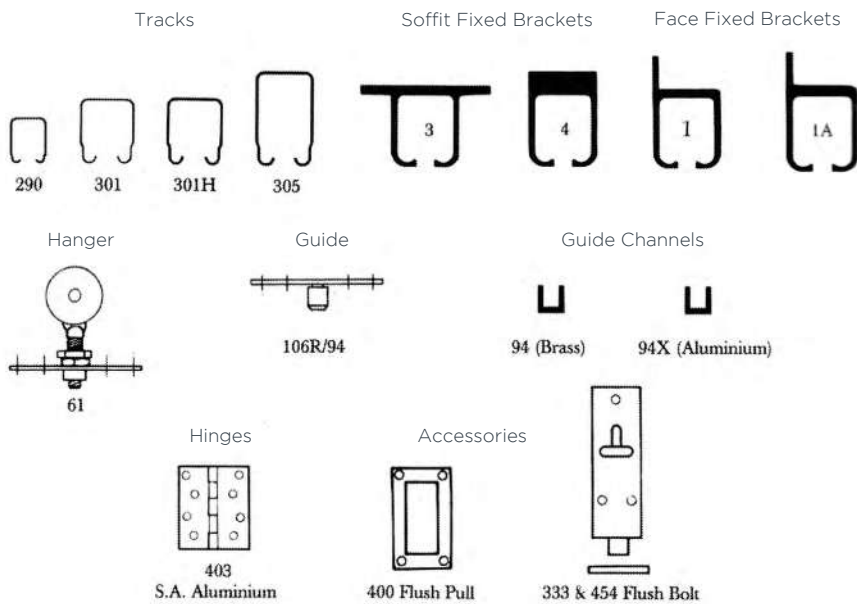

**EXAMPLE PLAN DETAILS**

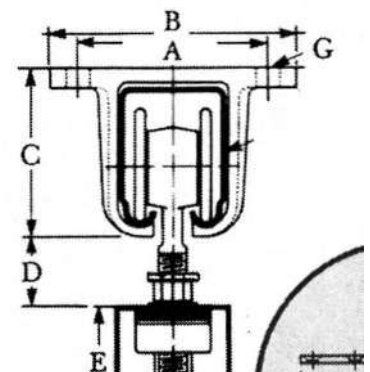

Accessories [View our full range of door handles and flush pulls on pages 128 and 129.](#)



# COUNCIL ENDFOLD

For end folding wooden partition doors weighing up to 35kg, 55kg 70kg and 80kg



Council Endfold is a quality range of top hung, folding partition systems for wooden doors.

Four systems are available catering for a maximum door weight of 80kg. Ideally suited for residential and commercial partitions, Council Endfold can cover any width of opening with any number of folding doors.

Folding units of up to eight doors can be hinged to post and floating units must consist of four, six or eight doors, with a minimum clearance of 2mm between each one.

Any access doors used with the systems should be a swing door or a wicket door housed within one of the main doors. No more than 6 doors should be hinged together and can be hinged to jam or floating.

A swinging pass door is obtained by using a 3 or 5 door unit up to 3000mm high or an independently hung door.

## Product Information

Product	Max. Door Height	Max. Door Width	Door Thickness Range	Max. Door Weight
Council Endfold 290	2700mm	900mm	35 - 44mm	35kg
Council Endfold 301	3300mm	900mm	44 - 57mm	55kg
Council Endfold 301H	3600mm	900mm	44 - 57mm	70kg
Council Endfold 305	4500mm	900mm	44 - 57mm	80kg

## Product Specification

Component	Description	290	301	301H	305
Track Equal to opening width	Galvanised steel track available in 2000, 2500, 3000, 4000 and 6000mm lengths	290/****	301/****	301H/****	305/****
Brackets Fix every 900mm max and at track joints. Fix extra bracket where doors stack.	Soffit fixed bracket	3A/290	3A/301	3A/301	3A/305
Hangers every 2 leaves (+end leaf of floating unit only)	End folding hanger, steel wheels	21K/S	21A/S	21A/S	21C/S
	End folding hanger, nylon wheels	21K/N	21A/N	21A/N	-
	End folding hanger for swing leaf	21K/4N	21A/4S	21A/4S	21C/4S
	End folding hanger, steel wheels (4)	21K/4S	-	-	-
	End folding pivot set	21K/P	21A/P	21A/P	-
Hinges 3 in height (increase to 4 for doors over 3000mm high).	Butt hinge	403/1	403/2	403/2	403/3
	Alternative pivot set where equal width leaves are to be anchored at one end	21K/P	21A/P	21A/P	-
Guides 1 every 2 doors (plus end door of floating unit only)	End folding guide	21KR/94	21R/94	21R/94	21R/94
Guide Channel	Brass guide channel available in 1500 and 3000mm lengths	94/****	94/****	94/****	94/****
	Aluminium guide channel available in 1500, 2000, 2500 and 3000mm lengths.	94X/****	94X/****	94X/****	94X/****

\*\*\*\* replace by length of track for full short code

**SECTION DETAILS**

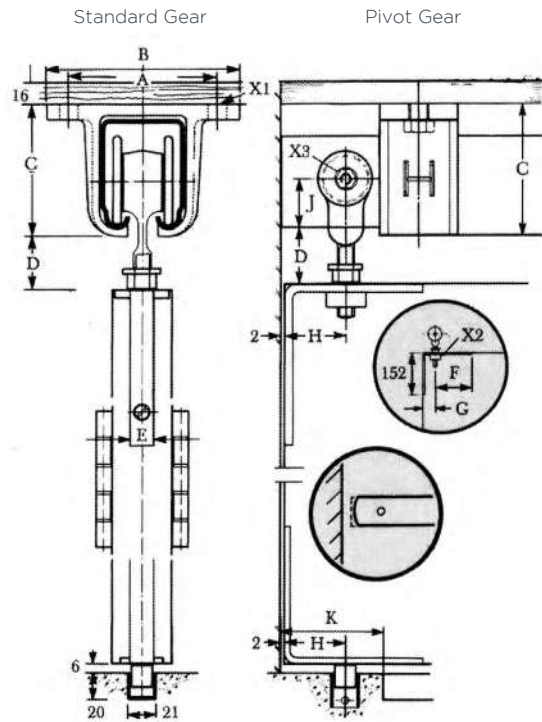
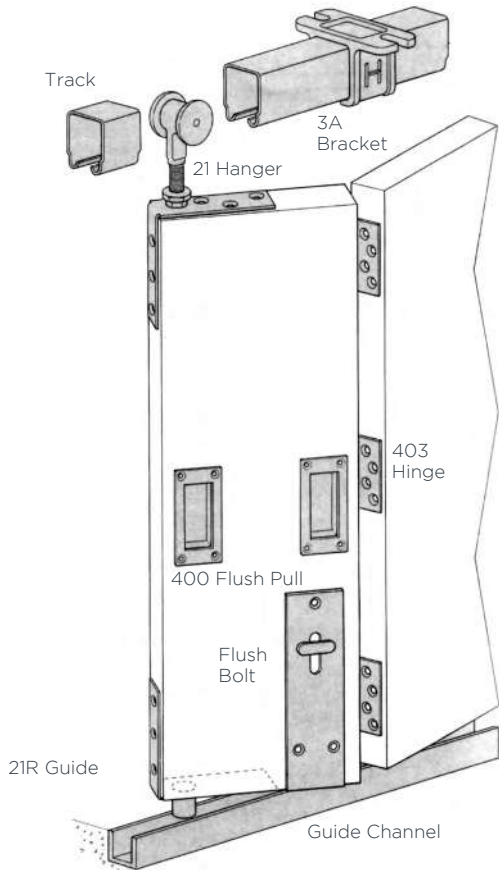

**Dimensions**

Track	A	B	C	D	E	F	G	H	J	K	X1	X2	X3
290	64	83	56	20	13	114	38	38	20	70	M8	13	M6
301/301H	100	130	86	45	18	133	45	45	35	75	M12	20	M8
305	125	168	121	60	18	133	45				M16	29	

**CHOICE OF GEARS**

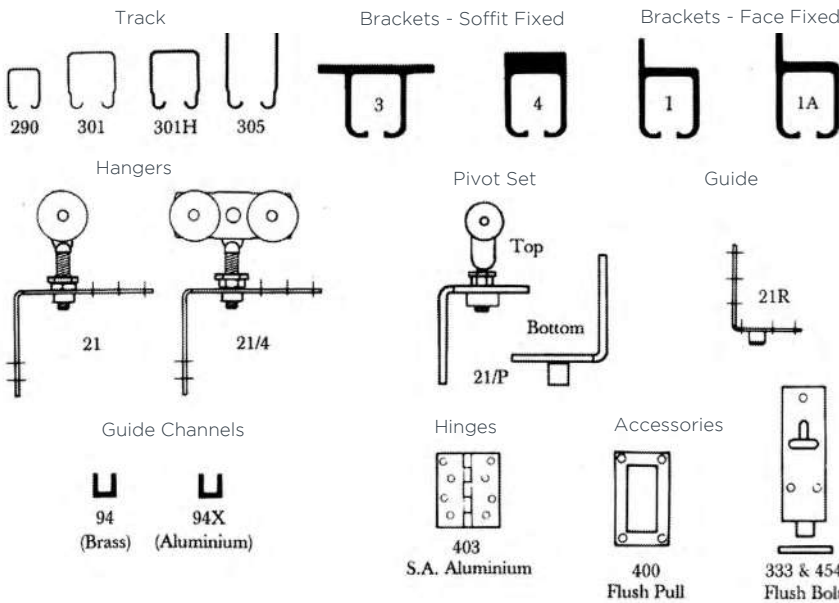

**EXAMPLE PLAN DETAILS**

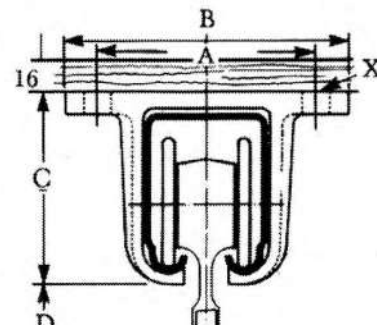

Accessories [View our full range of door handles and flush pulls on pages 128 and 129.](#)

# FLEXIROL ENDFOLD

For heavy weight end folding partition doors weighing up to 125kg



Flexirol Endfold has been specifically designed for commercial applications requiring heavy weight, top hung folding doors. Designed as an end folding system, the product can cater for interior wooden doors and exterior aluminium doors with leaves being able to be hung to the left or right of an opening or alternatively hung as a floating unit.

## Product Information

Product	Application	Door Material	Max. Door Height	Max. Door Width	Door Thickness Range	Max. Door Weight
Flexirol Endfold	Interior	Wood	4500mm	1200mm	43 - 57mm	125kg
	Exterior	Aluminium				

## Product Specification

Component	Description	Interior Short Code	Exterior Short Code
Track	White aluminium track available in 2000, 3000, 4000, 5000 and 6000mm lengths	550/****	550/****
	Aluminium mill finish track available in 2000, 3000, 4000, 5000 and 6000mm lengths	550/****M	550/****M
Brackets	Face fixed bracket (fixed at 500mm intervals)	1A/550	1A/550
	Soffit fixed adjustable, suspended ceiling bracket	3S/550	3S/550
Hangers *With stainless steel strap bolt.	Angle plate fixing hanger	556/21	556A/221*
Pivots	Top and bottom pivot set	21/550P	-
Guides	Brass end guide roller	21R/94	
	Intermediate guide with 150mm spindle, no hinge	-	67BA/220
	End guide with 110mm spindle, no hinge	-	67BA/180
Guide Channel	Brass guide channel available in 1500 and 3000mm lengths	94/****	94/****
	Aluminium guide channel available in 1500, 2000, 2500, 3000, 4000 and 6000mm lengths	94X/****	94X/****
	Aluminium threshold guide channel available in 2000, 2500, 3000, 3500, 4000 and 6000mm lengths	94T/****	94T/****
	Polypropylene guide channel available in 3000, 4000 and 6000mm lengths	94P/****	94P/****
	Anodised aluminium support channel available in 3000, 4000 and 6000mm lengths	94SC/****	94SC/****
Hinges	Butt hinge - 100 x 75mm	403/3	-
	20mm single hinge	-	65B/20/1
	20mm double hinge	-	65/20
	40mm single hinge	-	65B/40/1
	40mm double hinge	-	65B/40
	20 - 40mm double hinge	-	65B/20-40
Mounting Kit	To be used in conjunction with 65B hinge		60B

\*\*\*\* replace by length of track for full short code

### FLEXIROL ENDFOLD INTERIOR

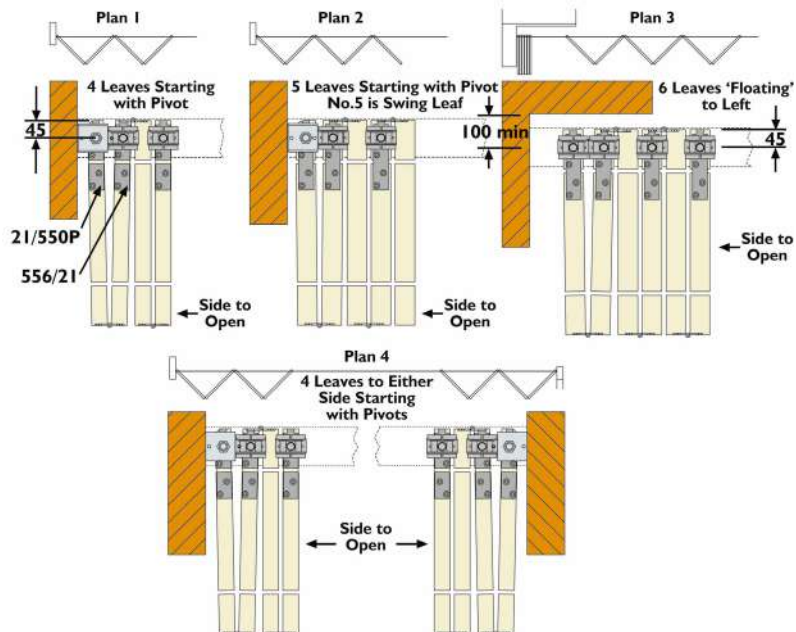
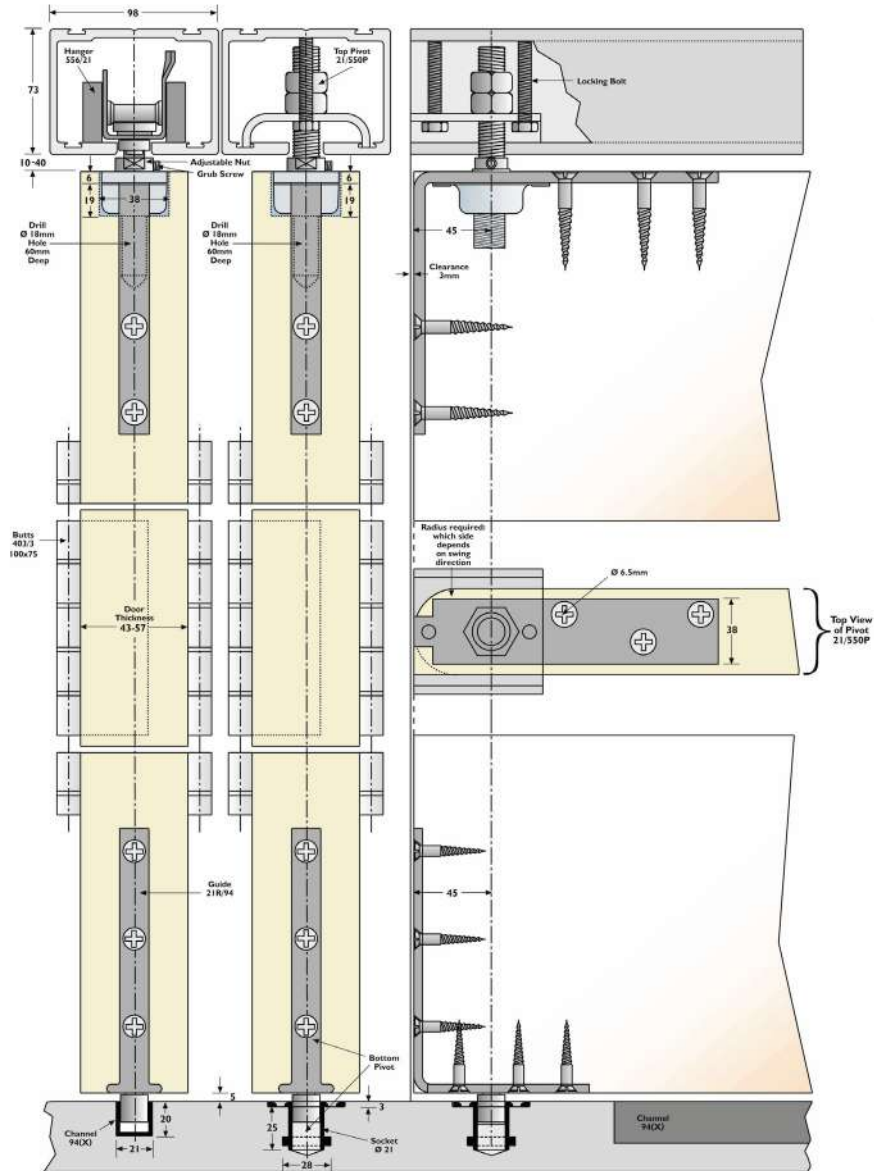



**FLEXIROL ENDFOLD EXTERIOR**

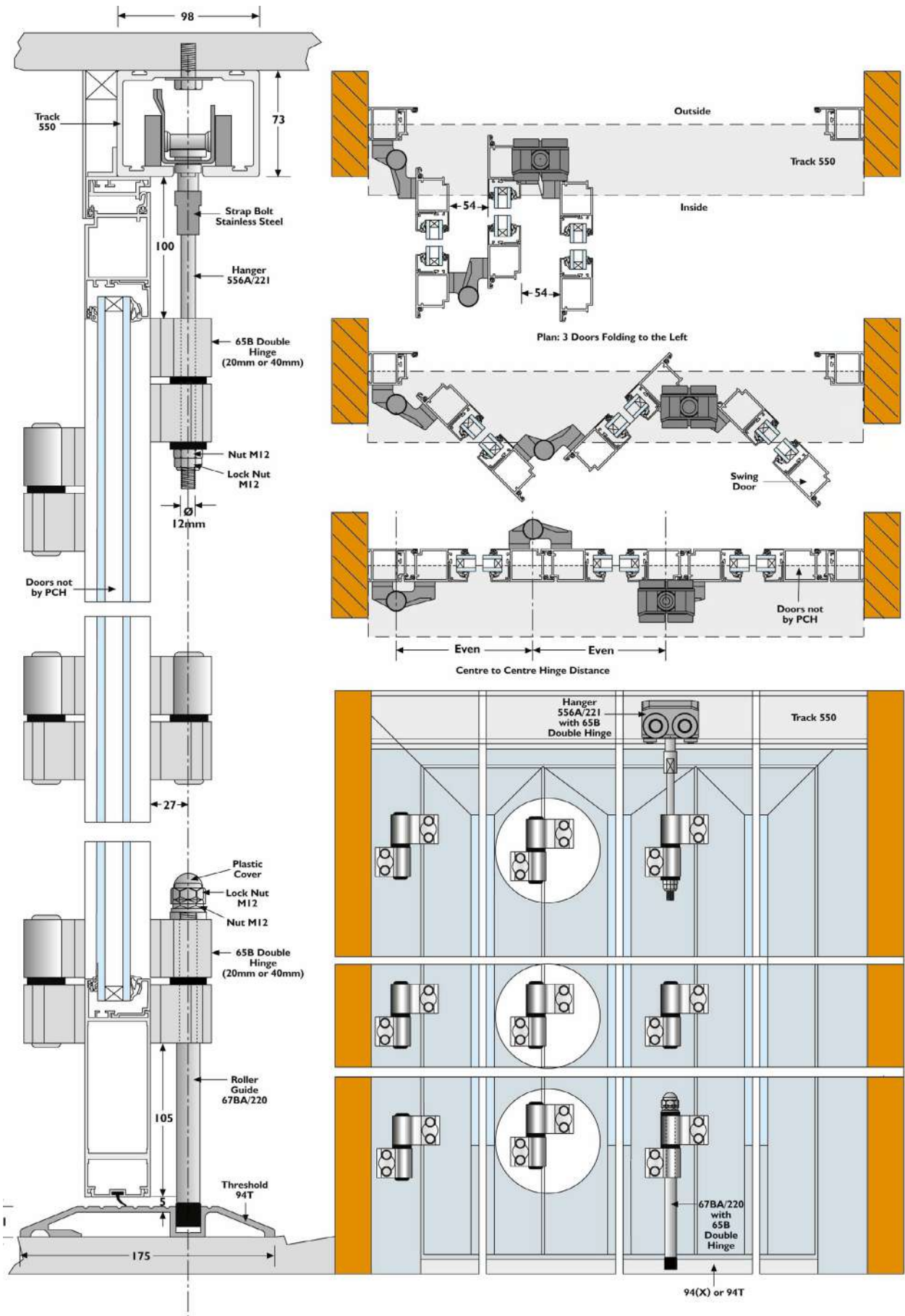

# FLEXIROL CENTREFOLD

For heavyweight centre folding wooden partition doors weighing up to 125kg



Specifically designed for commercial applications requiring heavyweight, top hung, central folding wooden partition doors. Doors are hung centrally and can fold to one or both sides. For applications hinged to the jam 3.5, 5.5 or 7.5 doors can be used with the half door hinged to the jam. For best operation of floating units, 5, 7 or 9 doors should be used. Any access doors should be hinged separately to the jam.

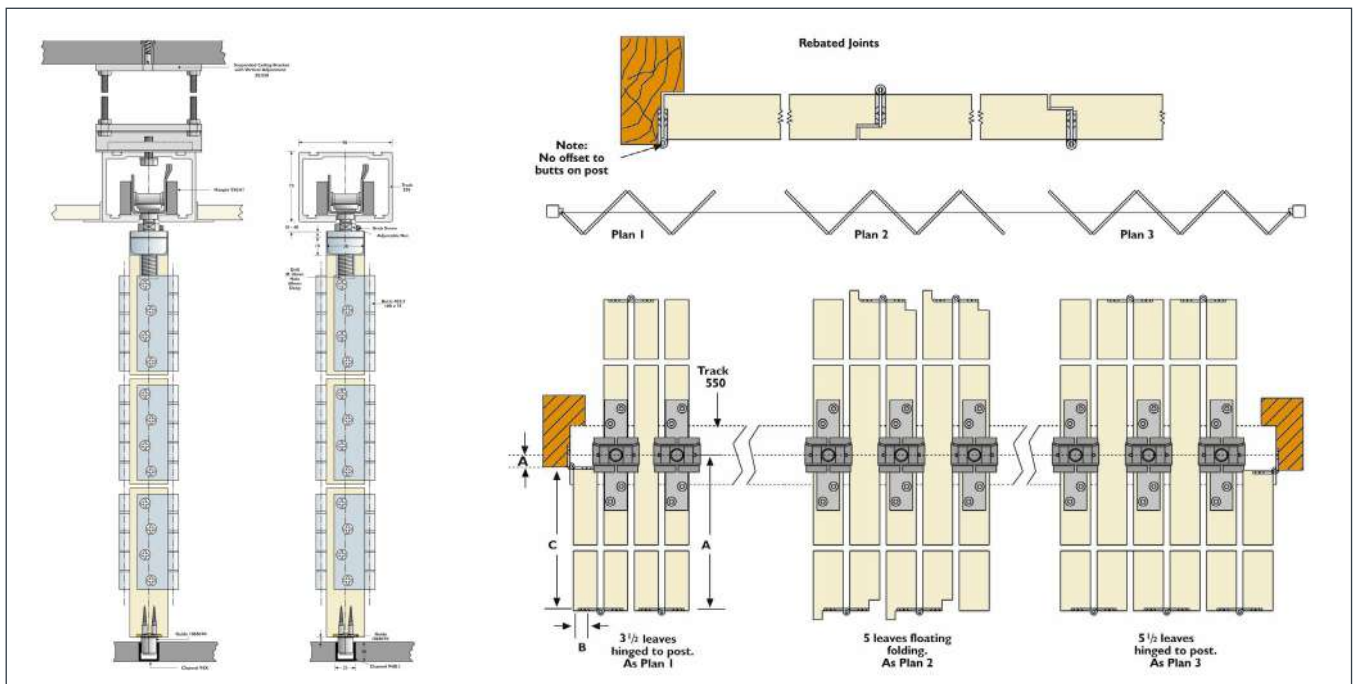

## Product Information

Product	Max. Door Height	Max. Door Width	Door Thickness Range	Max. Door Weight
Flexirol Centrefold	4500mm	1200mm	43 - 57mm	125kg

## Product Specification

Component	Description	Short Code
Track Equal to opening width	White aluminium track available in 2000, 3000, 4000, 5000 and 6000mm lengths	550/****
	Aluminium mill finish track available in 2000, 3000, 4000, 5000 and 6000mm lengths	550/****M
Brackets At 500mm intervals	Face fixed bracket	1A/550
	Soffit fixed bracket, adjustable	3S/550
Hangers	Top fixing plate hanger	556/61
Guides	Nylon roller guide	106N/94
Guide Channel	Brass guide channel available in 1500 and 3000mm lengths	94/****
	Aluminium guide channel available in 1500, 2000, 2500 and 3000mm lengths	94X/****
	Aluminium threshold available in 2000, 2500, 3000, 3500, 4000 and 6000mm lengths	94T/****
Hinges	Butt hinge	403/3

\*\*\*\* replace by length of track for full short code

Accessories [View our full range of door handles and flush pulls on pages 128 and 129.](#)

# COLLEGE CENTREFOLD

For internal bottom rolling wooden doors weighing up to 70kg and 140kg



College Centrefold is a high quality, bottom rolling system that is ideally suited for high class joinery installations due to all visible parts being in an attractive finish. The system is suitable for any width of opening as any number of doors can be used.

Folding units of up to seven full doors can be hinged to post whilst floating doors must be in configurations of three, five or seven doors with a clearance of 2mm between each door.

College Centrefold offers the opportunity to house access doors in the form of a swing door or a wicket door contained within one of the doors. It is essential that all doors are of equal width, instructions to calculate the optimum width for your opening size can be found in the fitting instructions. It is worth noting that doors should be constructed to provide secure fixings for bottom rollers, hinges and top guide rollers and can either be flush, panelled or glazed. Minimum 200mm bottom rails and 150mm stiles are also recommended.

## Product Information

Product	Max. Door Height	Max. Door Width	Door Thickness Range	Max. Door Weight
College Centrefold 70	3600mm	1000mm	44mm	70kg
College Centrefold 140	5500mm	1000mm	54mm	140kg

## Product Specification

Component	Description	College Centrefold 70	College Centrefold 140
Top Guide Channel	Top guide channel available in 2000, 2500 and 3000mm lengths	900/****	900/****
Brackets Fix every 600mm max and at channel joints. Fix every bracket where doors stack.	Soffit fixed bracket	3/900	3/900
Top Guide Rollers 1 every 2 leaves	For wooden doors, light duty For wooden doors, heavy duty, standard fitting	901/909L 901/919H	- 901/919HD
Hinges 3 in height	Concealed butt hinge, satin anodised aluminium	403/2	403/3
Bottom Rollers 1 every 2 leaves	Wooden door, standard fitting Wooden doors, concealed fitting	920 923	909H -
Bottom Rail Same length as guide channel	Bottom rail available in 1500 and 3000mm lengths	918	917

\*\*\*\* replace by length of track for full short code

## Accessories



Lug for Fixing Rails into Concrete (917/918 Lug)



Cup for Fixing Rails into Concrete (917/918 Cup)

**View our full range of door handles and flush pulls on pages 128 and 129.**

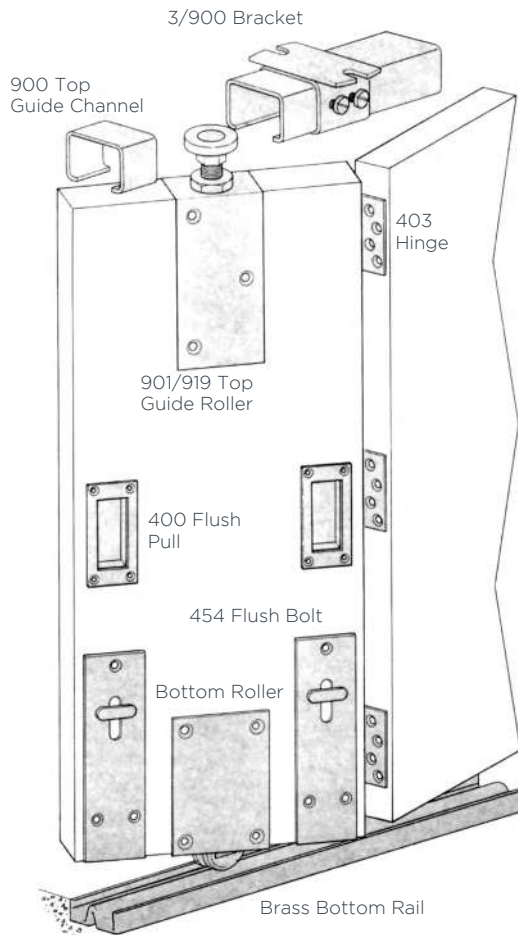

**SECTION DETAILS**

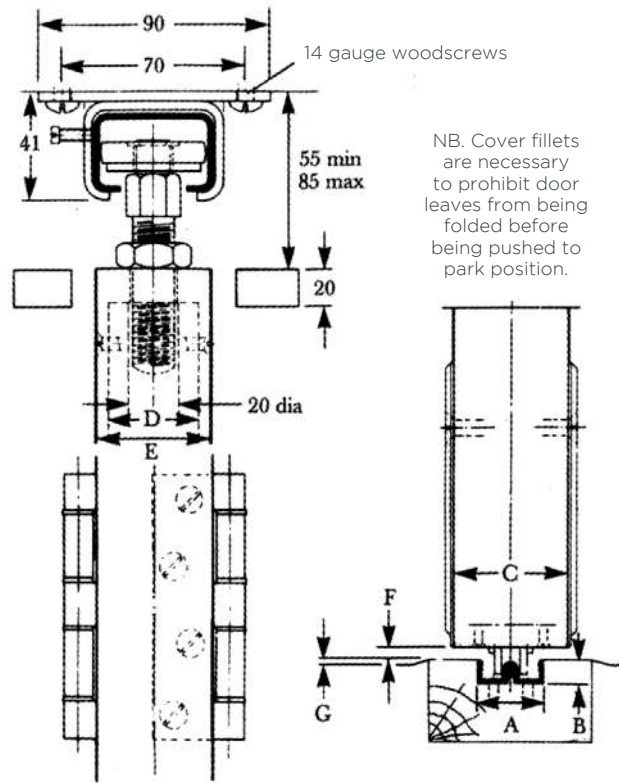

**Dimensions**

Product	A	B	C	D	E	F	G
College Centrefold 70	25	10	44	34	44	5	2
College Centrefold 140	35	13	54	44	54	6	3

**CHOICE OF GEARS**

Top Guide



Brackets - Soffit Fixed

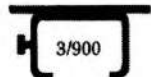

Brackets - Face Fixed

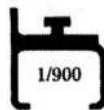

Top Guide Rollers

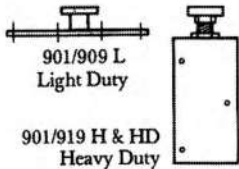

Hinges

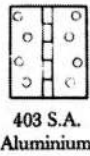

Bottom Rollers

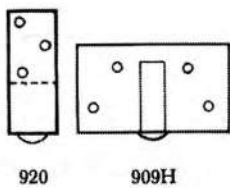

Accessories

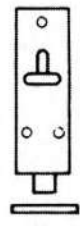
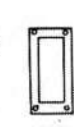

Brass Rail

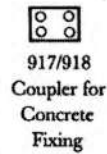
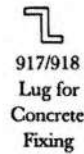

**EXAMPLE PLAN DETAILS**

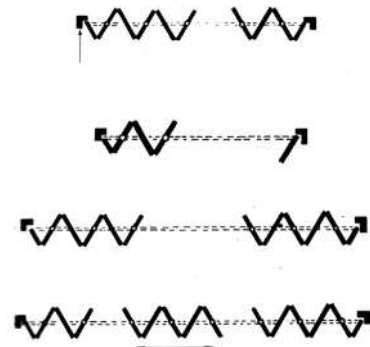



# COLLEGE ENDFOLD

For internal bottom rolling wooden doors hinged to a post or floating



College Endfold is a high quality bottom rolling system that is ideally suited for high class joinery installations due to the visible parts being in an attractive satin anodised aluminium finish. The system is suitable for any width of opening as any number of doors can be used.

Folding units of up to eight doors can be hinged to post whilst floating leaves must be in configurations of four, six or eight doors with a clearance of 2mm between each door.

College Endfold offers the opportunity to house access doors in the form of a swing door or a wicket door contained within one of the doors. It is essential that all doors are of equal width, instructions to calculate the optimum width for your opening size can be found in the fitting instructions. It is worth noting that door leaves should be constructed to provide secure fixing for bottom rollers, hinges and top guide rollers and can either be flush, panelled or glazed. Minimum 200mm bottom rails and 150mm stiles are also recommended.

## Product Information

Product	Max. Door Height	Max. Door Width	Door Thickness Range	Max. Door Weight
College Endfold 70	3600mm	900mm	44mm	70kg
College Endfold 140	5500mm	900mm	54mm	140kg

## Product Specification

Component	Description	College Endfold 70	College Endfold 140
Top Guide Channel	Top guide channel available in 2000, 2500 and 3000mm lengths	900/****	900/****
Brackets Fix every 600mm max and at channel joints. Fix every bracket where doors stack.	Soffit fixed bracket	3/900	3/900
Top Guide Rollers 1 every 2 leaves	For wooden doors, light duty	901/919L	-
	For wooden doors, heavy duty, standard fitting	901/919H	901/919HD
Hinges 3 in height	Concealed butt hinge SAA	403/2	403/3
Bottom Rollers 1 every 2 leaves	Wood door, standard fitting	920	919H
	Wood door, concealed fitting	923	-
Bottom Rollers Same length as top guide channel	Bottom Rail available in 1500 and 3000mm lengths	918/****	917/****

\*\*\*\* replace by length of track for full short code

## Accessories



Lug for Fixing Rails  
(917/918 Lug)



Cup for Fixing Rails  
(917/918 Cup)

**View our full range of door handles and flush pulls on pages 128 and 129.**

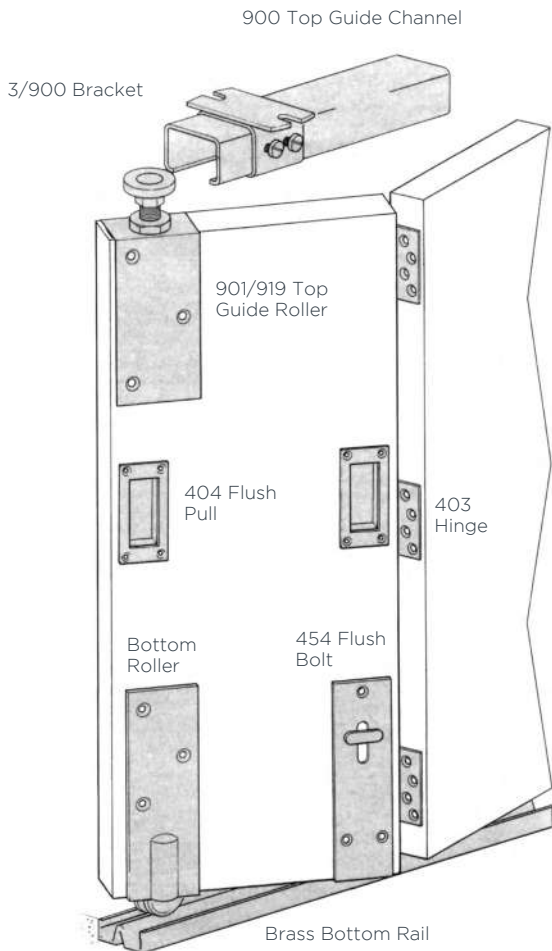

### SECTION DETAILS

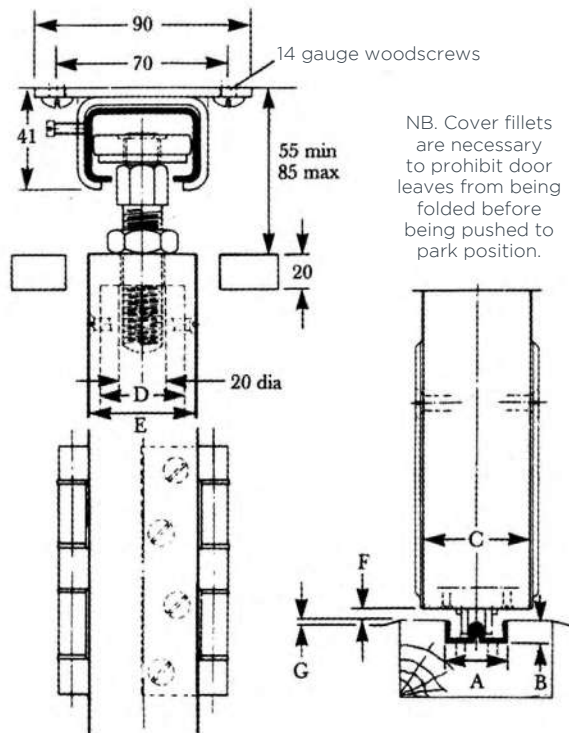

### Dimensions

A	B	C	D	E	F	G
25	10	38	38	12	5	2

### CHOICE OF GEARS

Top Guide



Soffit Fixed Bracket



Face Fixed Bracket



Top Guide Rollers

for door leaf sizes <300mm wide 2400mm high



901/919 H & HD Heavy Duty



Hinges



403 S.A. Aluminium



403/4 Polished Brass

Bottom Rollers

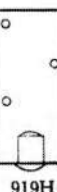

920

919H

Accessories



923 Concealed Roller



400 Flush Pull

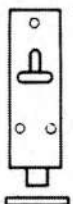

454 Flush Bolt



917 & 918

Brass Rail

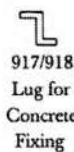

917/918 Lug for Concrete Fixing

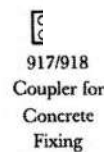

917/918 Coupler for Concrete Fixing

### EXAMPLE PLAN DETAILS

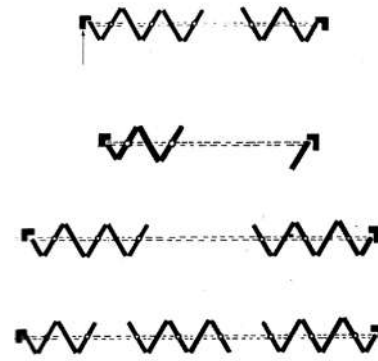

# SECUREFOLD

The ultimate folding door hardware system for doors weighing up to 50kg, 100kg and 150kg



Securefold 100 hanger featuring R-Loc



Choose from a choice of four stunning finishes

Securefold offers the very best in exterior folding door hardware systems to help you securely open up a home to the outside world. The system has been designed for residential and commercial applications for top hung, exterior wooden doors weighing up to 50kg, 100kg and 150kg. With all components made from marine grade 316 stainless steel, the system is extremely resistant against the elements and corrosion. The system comes in a range of stunning finishes including satin, chrome, gold and black meaning it can complement existing hardware and virtually any colour scheme.

The system operates with effortless ease and combines all the aesthetic benefits of folding wooden doors with the additional advantages of uncompromising security and durability.

Securefold 100 features all the benefits of both the 50 and 150 with the addition of a further enhancement, R-Loc - a clever ratchet system that enables installers to easily raise or lower a door.

## Securefold Specifier

Use our online Securefold Specifier tool to quickly build a bill of materials or get a quotation [www.pchenderson.com/securefold-specifier](http://www.pchenderson.com/securefold-specifier)

## Product Information

Product	Max. Door Height	Max. Door Width	Door Thickness Range*	Max. Door Weight
Securefold 50	3300mm	1000mm	35 - 68mm	50kg
Securefold 100	3300mm	1000mm	35 - 68mm	100kg
Securefold 150	4000mm	1200mm	45 - 68mm	150kg

\*For thick and/or narrow width doors please consult the fitting instructions regarding 'camming'.



## Product Specification

Component	Description	Securefold 50	Securefold 100	Securefold 150
Track	2500 and 3500mm lengths not available for 480 track			
	Anodised aluminium track available in 2000, 2500, 3000, 3500, 4000, 5000 and 6000mm lengths.	180/****	250/****	480/****
Pivot	Pivot assembly, mortice	SF1#50	SF1#	SF1S150
Hanger	End hanger, mortice, left hand - handed inside looking out*	SF2L#50	SF2L#	-
	End hanger, mortice, right hand - handed inside looking out*	SF2R#50	SF2R#	-
	End hanger set in satin	-	-	SF2S150
	Intermediate hanger set kit	SF4#50	SF4#	SF4S150
	End hanger meeting kit, mortice	SF8#50	SF8#	SF8S150
Hinges	Hinge handle set outward opening	SF3#	SF3#	SF3S150
	Hinge set inward opening	SF5#	SF5#	-
	Hinge set offset inward opening	SF6#	SF6#	-
	Hinge handle offset outward opening	SF7#	SF7#	SF7S150
	Intermediate pivot hinge, mortice	SF9#	SF9#	SF9S150
Channel	Aluminium threshold in satin with endcaps available in 2000, 2500, 3000, 3500, 4000 and 6000mm lengths	SF94T/****	SF94T/****	-
	Aluminium threshold in bronze with endcaps available in 2000, 2500, 3000, 3500, 4000 and 6000mm lengths	SF94T/****BZ	SF94T/****BZ	-
	Polypropylene channel in black available in 2000, 3000, 3500, 4000, 5000 and 6000mm lengths	94P/****	94P/****	98P/****
	Anodised aluminium support channel available in 2000, 3000, 3500, 4000, 5000 and 6000mm lengths	94SC/****	94SC/****	98SC/****
Seals	Door perimeter seal in brown	AQ63B	AQ63B	AQ33B
	Frame perimeter seal in brown	AQ21B	AQ21B	AQ21B
	Track seal in black - 10mm	BS10B	BS10B	BS10B
Flushbolts*	Non lockable flush bolt in 190, 450 and 600mm lengths	SF190#/SF450#/SF600#		
	Lockable flush bolt in 190, 450 and 600mm lengths	SF190L#/SF450L#/SF600L#		
	Non lockable, inward opening, bottom flush bolt in 190mm length	SF190IB#		
	Lockable, inward opening, bottom flush bolt in 190mm length	SF190IBL#		
	Non lockable, inward opening, top flush bolt in 190, 450 & 600mm lengths	SF190IT#/SF450IT#/SF600IT#		

\*\* replace with brush height for full short code

\*\*\*\* replace by length of track for full short code

# replace with first letter of required colour for full short code - gold, black, satin or chrome \*Inward opening flush bolts not suitable for Securefold 150

Hinge options include standard Securefold (SF), mortice squared (SFM), mortice radius corner (SFR) and non-mortice (SFW), see page 96 for details.

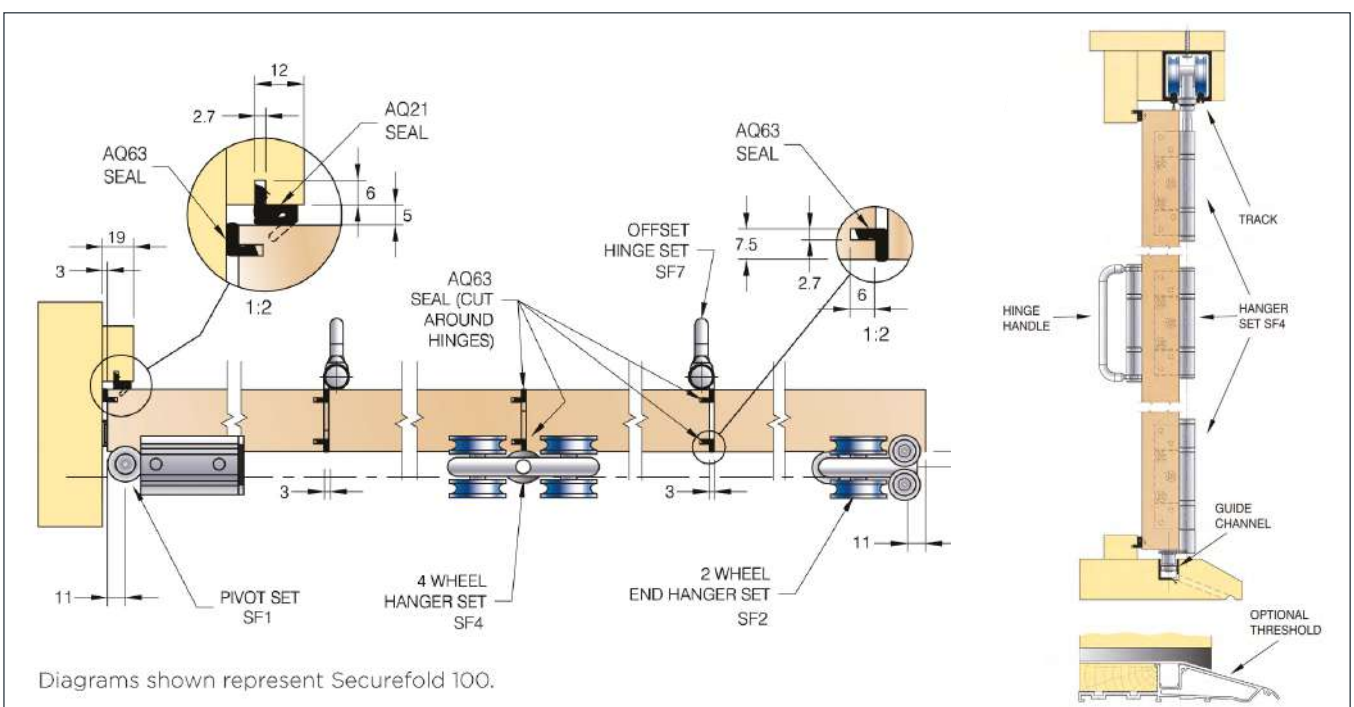

## Accessories

View our full range of door handles and flush pulls on pages 128 and 129.



Outward Door Configurations and Hardware Quantities

Door Configuration	Hardware	Securefold Ultra Hardware Kits**
<b>2 Leaf</b> <p>INSIDE OUTSIDE</p> <p>● = Flushbolt location</p>	2 x SF flushbolt, 1 x SF1 pivot set, 1 x SF3 hinge set with handle, 1 x SF2L end hanger set - left hand.*	1 x SFU1, 1 x SFU9, 1 x SFU2
<b>2 + 1 Leaf</b> <p>INSIDE OUTSIDE</p>	2 x SF flushbolt, 2 x SF1 pivot set, 1 x SF3 hinge set with handle, 1 x SF2L end hanger set - left hand.*	2 x SFU1, 2 x SFU2, 2 x SFU9
<b>3 Leaf</b> <p>INSIDE OUTSIDE</p>	2 x SF flushbolt, 1 x SF1 pivot set, 1 x SF4 intermediate hanger set, 1 x SF7 offset hinge set with handle.	1 x SFU1, 1 x SFU9, 1 x SFU4
<b>2 + 2 Leaf</b> <p>INSIDE OUTSIDE</p>	4 x SF flushbolt, 2 x SF1 pivot set, 2 x SF3 hinge set with handle, 1 x SF8 rebated end hanger meeting.	2 x SFU1, 2 x SFU9
<b>3 + 1 Leaf</b> <p>INSIDE OUTSIDE</p>	4 x SF flushbolt, 2 x SF1 pivot set, 1 x SF4 intermediate hanger set, 1 x SF7 offset hinge set with handle.	2 x SFU1, 2 x SFU9, 1 x SFU4
<b>4 Leaf</b> <p>INSIDE OUTSIDE</p>	4 x SF flushbolt, 1 x SF1 pivot set, 1 x SF4 intermediate hanger set, 2 x SF7 offset hinge set with handle, 1 x SF2L end hanger set - left hand.*	1 x SFU1, 1 x SFU9, 1 x SFU4, 1 x SFU2
<b>3 + 2 Leaf</b> <p>INSIDE OUTSIDE</p>	4 x SF flushbolt, 2 x SF1 pivot set, 1 x SF3 hinge set with handle, 1 x SF4 intermediate hanger set, 1 x SF7 offset hinge set with handle, 1 x SF2R end hanger set - right hand.*	2 x SFU1, 2 x SFU9, 1 x SFU4, 1 x SFU2
<b>4 + 1 Leaf</b> <p>INSIDE OUTSIDE</p>	4 x SF flushbolt, 2 x SF1 pivot set, 1 x SF4 intermediate hanger set, 2 x SF7 offset hinge set with handle, 1 x SF2L end hanger set - left hand.*	2 x SFU1, 2 x SFU9, 1 x SFU4, 1 x SFU2
<b>5 Leaf</b> <p>INSIDE OUTSIDE</p>	4 x SF flushbolt, 1 x SF1 pivot set, 1 x SF3 hinge set with handle, 2 x SF4 intermediate hanger set, 1 x SF7 offset hinge set with handle.	1 x SFU1, 1 x SFU9, 2 x SFU4
<b>3 + 3 Leaf</b> <p>INSIDE OUTSIDE</p>	6 x SF flushbolt, 2 x SF1 pivot set, 2 x SF4 intermediate hanger set, 2 x SF7 offset hinge set with handle.	2 x SFU1, 2 x SFU9, 2 x SFU4
<b>4 + 2 Leaf</b> <p>INSIDE OUTSIDE</p>	6 x SF flushbolt, 2 x SF1 pivot set, 1 x SF3 hinge set with handle, 1 x SF4 intermediate hanger set, 2 x SF7 offset hinge set with handle, 1 x SF8 rebated end hanger meeting.	2 x SFU1, 2 x SFU9, 1 x SFU4
<b>5 + 1 Leaf</b> <p>INSIDE OUTSIDE</p>	6 x SF flushbolt, 2 x SF1 pivot set, 1 x SF3 hinge set with handle, 2 x SF4 intermediate hanger set, 1 x SF7 offset hinge set with handle.	2 x SFU1, 2 x SFU9, 2 x SFU4
<b>6 Leaf</b> <p>INSIDE OUTSIDE</p>	6 x SF flushbolt, 1 x SF1 pivot set, 1 x SF3 hinge set with handle, 2 x SF4 intermediate hanger set, 2 x SF7 offset hinge set with handle, 1 x SF2L end hanger set - left hand.*	1 x SFU1, 1 x SFU9, 2 x SFU4, 1 x SFU2

Product Information

SF1 pivot assembly set	SF7 hinge set offset outward opening
SF2R end hanger set (RH)	SF8 rebated end hanger meeting
SF2L end hanger set (LH)	SF9 intermediate pivot hinge (optional)
SF4 intermediate hanger set	SF10 face fix handle (optional)
SF5 hinge set inward opening	SF flushbolt
SF3 hinge set with handle	

To add surface mounted hinges replace:

- SF1 with SFW1
  - SF2 with SFW2
  - SF8 with SFW8
  - SF9 with SFW9
- (only available for standard Securefold)

\*All Securefold Ultra hardware kits come complete with certified hardware, multipoint lock-available in brushed satin, polished stainless steel, titanium gold and black finishes. Specify only track and seals required to complete the specification.

The configurations shown above are viewed from the outside. They can be reversed, if reversed the parts marked \* will have to be the opposite handing e.g. "SFW2R/SF2R end hanger set - right hand" will become "SFW2L/SF2L end hanger set - left hand" and "SFW2L/SF2L end hanger set - left hand" will become "SFW2R/SF2R end hanger set - right hand". SFW9 intermediate pivot is optional for doors exceeding 2200mm in height. The SFW8 (rebated end hanger meeting) is illustrated in the split position on each door. Only one kit is required per door meeting point. \*\* Ultra only available outward opening. On systems using door leaves that are narrow and wide and the hypotenuse is more than the door width x 1.004 then a risk of camming exists (see fitting instructions for further information). Please contact our Technical Customer Services Team for further information.

## HARDWARE APPLICATION

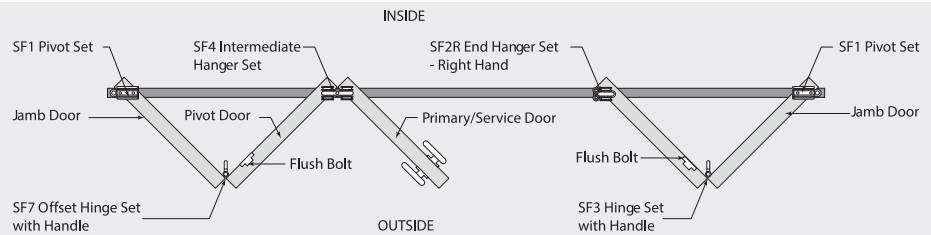

### Inward Door Configurations and Hardware Quantities

Door Configuration		Securefold hardware
<b>2 Leaf</b>		2 x SF flushbolt, 1 x SF1 pivot set, 1 x SF5 hinge set inward opening, 1 x SF2R end hanger set - right hand.*
<b>2 + 1 Leaf</b>		2 x SF flushbolt, 2 x SF1 pivot set, 1 x SF5 hinge set inward opening, 1 x SF2R end hanger set - right hand*
<b>3 Leaf</b>		2 x SF flushbolt, 1 x SF1 pivot set, 1 x SF6 offset hinge set inward opening, 1 x SF4 intermediate hanger set.
<b>2 + 2 Leaf</b>		4 x SF flushbolt, 2 x SF1 pivot set, 2 x SF5 hinge set inward opening, 1 x SF8 rebated end hanger meeting.
<b>3 + 1 Leaf</b>		4 x SF flushbolt, 2 x SF1 pivot set, 1 x SF6 offset hinge set inward opening, 1 x SF4 intermediate hanger set.
<b>4 Leaf</b>		4 x SF flushbolt, 1 x SF1 pivot set, 2 x SF6 offset hinge set inward opening, 1 x SF4 intermediate hanger set, 1 x SF2R end hanger set - right hand.*
<b>3 + 2 Leaf</b>		4 x SF flushbolt, 2 x SF1 pivot set, 1 x SF4 intermediate hanger set, 1 x SF5 hinge set inward opening, 1 x SF6 offset hinge set inward opening, 1 x SF2L end hanger set - left hand.*
<b>4 + 1 Leaf</b>		4 x SF flushbolt, 2 x SF1 pivot set, 1 x SF4 intermediate hanger set, 2 x SF6 offset hinge set inward opening, 1 x SF2R end hanger set - right hand.*
<b>5 Leaf</b>		4 x SF flushbolt, 1 x SF1 pivot set, 2 x SF4 intermediate hanger set, 1 x SF5 hinge set inward opening, 1 x SF6 offset hinge set inward opening.
<b>3 + 3 Leaf</b>		6 x SF flushbolt, 2 x SF1 pivot set, 2 x SF4 intermediate hanger set, 2 x SF6 offset hinge set inward opening.
<b>4 + 2 Leaf</b>		6 x SF flushbolt, 2 x SF1 pivot set, 1 x SF4 intermediate hanger set, 1 x SF5 hinge set inward opening, 2 x SF6 offset hinge set inward opening, 1 x SF8 rebated end hanger meeting.
<b>5 + 1 Leaf</b>		6 x SF flushbolt, 2 x SF1 pivot set, 2 x SF4 intermediate hanger set, 1 x SF5 hinge set inward opening, 1 x SF6 offset hinge set inward opening.
<b>6 Leaf</b>		6 x SF flushbolt, 1 x SF1 pivot set, 2 x SF4 intermediate hanger set, 1 x SF5 hinge set inward opening, 2 x SF6 offset hinge set inward opening, 1 x SF2R end hanger set - right hand.*

The configurations shown above are viewed from the inside. They can be reversed, if reversed the parts marked \* will have to be the opposite handing e.g. "SF2R end hanger set - right hand" will become "SF2L end hanger set - left hand" and "SF2L end hanger set - left hand" will become "SF2R end hanger set - right hand". The SF8 (rebated end hanger meeting) is illustrated in the split position on each door. Only one kit is required per door meeting point.

## HINGE OPTIONS

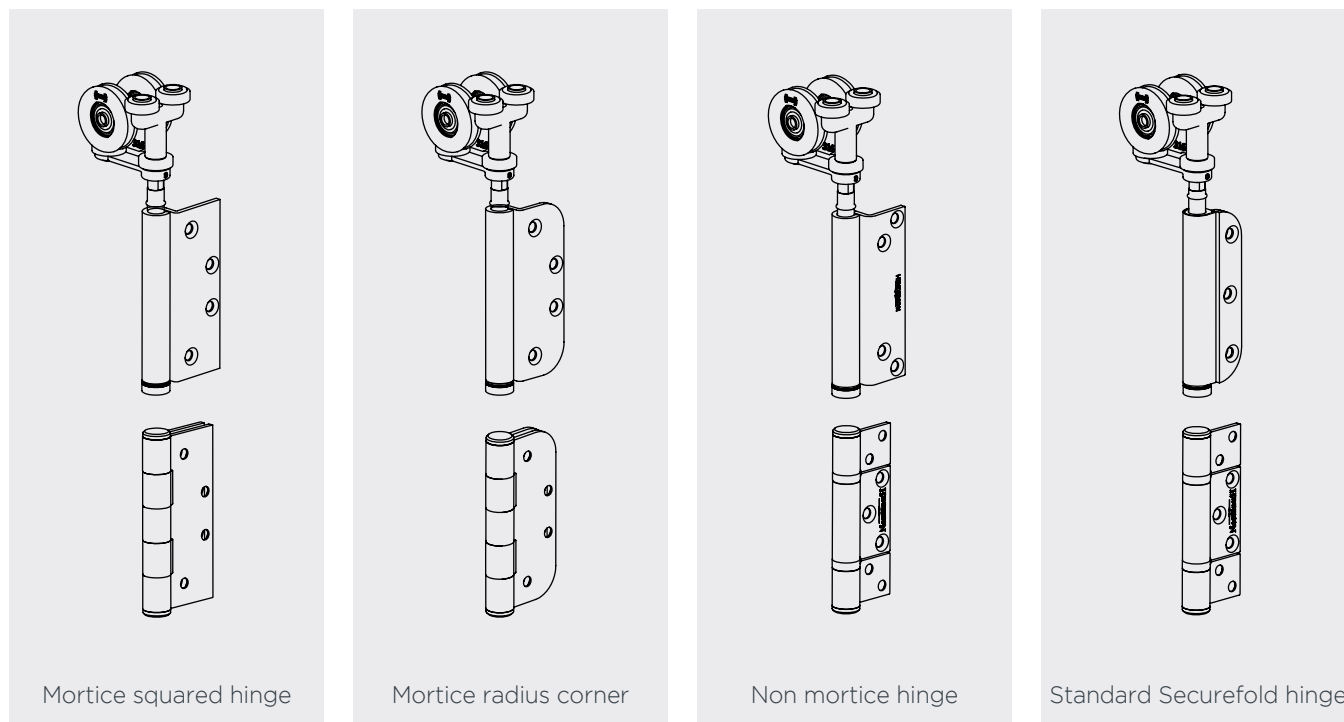

P C Henderson offer a choice of four different hinge options in the Securefold range\*, this enables us to offer our customers a choice in the look and feel of their project as well as variances on the preferred method of installation and door material.

### Mortice Squared Hinge

Square edged hinges provide a rustic feel and look to any wood work application and these are often chosen for more traditional applications. The solid square appearance achieves the look of a timely installation as in the past and historically would have required precision routing by hand. Today there are other methods but some customers still prefer the hand carved qualities of traditional joinery. This hinge option is suitable for use on timber panels between 44-68mm thick and weighing up to 100kg.

### Mortice Radius Corner

Radius cornered hinges offer a softer look and often suit the look and feel of contemporary applications.

The smooth round edge complements the trend for minimalistic installation with a clean and modern finish. These hinges lend themselves perfectly to machine routing which aid the routing and fitting process. This hinge option is suitable for use on timber panels between 44-68mm thick and weighing up to 100kg.

### Non Mortice Hinge

A non mortice hinge is an entirely surface mounted system that requires no routing or additional preparation before the fitting process. This is an easy and versatile option of hardware that is suitable for use on both the Securefold Timber and Securefold Aluminum. This option offers versatility and can be used on timber or aluminum panels between 35-68mm thick and weighing up to 100kg.

### Standard Securefold Hinge

The Securefold Standard hinge option combines morticed end leaf hinges to create a clean finish as it is concealed between the door and the jamb; it then uses the trusted surface mounted intermediate hinges for ease of installation across the remaining door configurations. Because of this, the standard hinge is suitable for all timber door leaves stated (35-68mm thick and weighing up to 100kg) and is a popular option when specifying internal or external folding.

\*excludes Securefold Ultra.

# Multidirectional



Our range of multidirectional door hardware systems offer unparalleled flexibility without compromising on the practicality of the application. The system offers a choice of two hangers providing either 90° or 135° movement for wooden, metal and glass panels weighing up to 100kg and 500kg.

The range is ideal for shopfronts, internal partitions, moveable walls, conference rooms, restaurants or any application that requires the flexibility of a stacking system which can be stored to the side, clear of the opening.

## Range Overview

- Catering for maximum door weights of up to 100kg and 500kg
- Available in 90° or 135° movement
- Suitable for wood, metal or glass panels
- Interior and exterior applications
- Panels stack to the side leaving a clear opening
- Ability to create bespoke stacking areas away from entrance



# FLEXIROL MULTIDIRECTIONAL

For light weight and heavy weight doors requiring 90° or 135° movement



Our Flexirol Multidirectional comes in two product variations - Flexirol Multidirectional 90 and Flexirol Multidirectional 135. The 90 degree system is designed for panels up to 100kg, requiring 90 degree movement options for both residential and commercial environments. The 135 degree system is designed for panels up to 500kg, for use in residential and commercial environments where 135 degree movement is required. The system can also be made entirely bespoke and tailored to your exact requirements.

Catering for wooden and aluminium doors, the system is ideal for shop fronts, internal room partitions, conference centres and showrooms. The stacking formation allows panels to be stored entirely clear of the opening.

## Product Information

Product	Max. Door Height	Max. Door Width	Door Thickness Range	Max. Swing Door Thickness	Max. Door Weight (1 Hanger per Door)	Max. Door Weight (2 Hangers per Door)
Flexirol Multidirectional 90	6000mm	6000mm	40 - 100mm	1200mm	50kg	100kg
Flexirol Multidirectional 135	6000mm	6000mm	40 - 100mm	1200mm	250kg	500kg

## Product Specification

Component	Description	Flexirol MD 90 Short Code	Flexirol MD 135 Short Code
Track	White aluminium track available in 2000, 3000, 4000, 5000 and 6000mm lengths	550/****	550/****
	Aluminium mill finish track available in 2000, 3000, 4000, 5000 and 6000mm lengths	550/****M	550/****M
Intersects	'T' junction	TW/550	-
	Cross-junction	KW/550	-
	135° right-hand	-	W45R/550
	135° left-hand	-	W45L/550
Elbows	90° elbow	H90/550	-
	135° swept elbow	-	H135/550
	90° swept elbow for 135° hanger	-	H90C/550
Brackets	Face fixed bracket	1A/550	1A/550
	Soffit fixed bracket - suspended ceiling	3S/550	3S/550
Hangers	Angle plate fixing	555/21	556/21
	Concealed fixing	555/61	556/61
	Metal hanger	555	556
Pivots	Pivot set	21/500P	21/500P

\*\*\*\* replace by length of track for full short code.

### FLEXIROL MULTIDIRECTIONAL 90

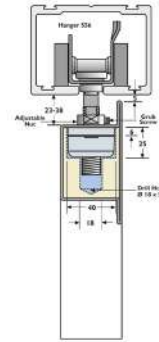
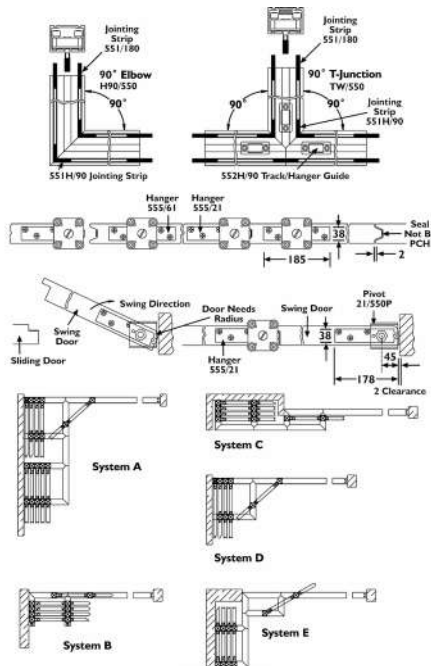
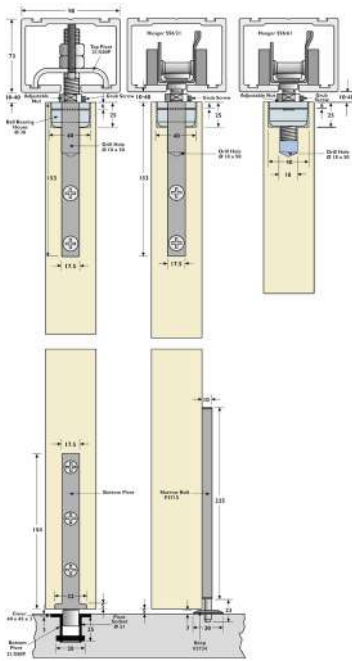

### FLEXIROL MULTIDIRECTIONAL 135

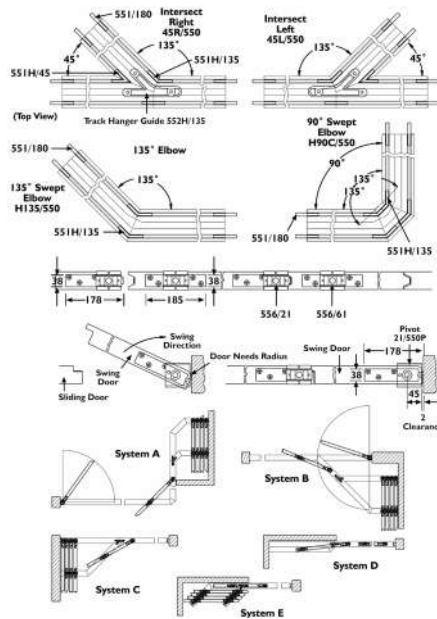
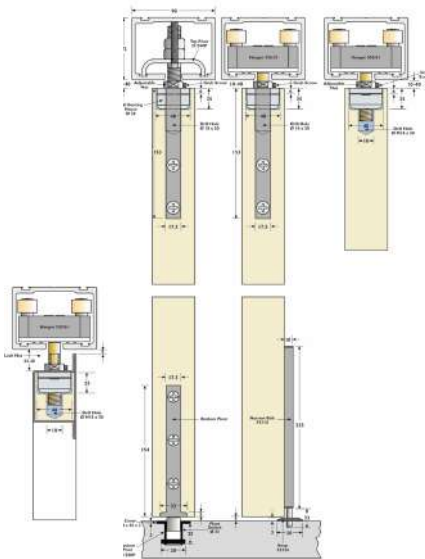

#### Accessories



Jointing Strip (551H/180)

View our full range of door handles and flush pulls on pages 128 and 129.

# FLEXIROL MULTIDIRECTIONAL GLASS

For glass doors weighing up to 100kg requiring 90° or 135° movement



Flexirol Multidirectional Glass is designed for glass panels, in residential or commercial environments, requiring 90° or 135° flexible movement options. The system is ideal for shop fronts of internal room partitions and also benefits from a stacking formation, which allows the doors to be stored clear of the threshold.

## Product Information

Product	Max. Door Height	Max. Door Width	Max. Swing Door Thickness	Glass Thickness	Max. Door Weight
Flexirol Multidirectional Glass 90	4000mm	1000mm per 100kg of glass	1200mm	10mm or 12mm	100kg
Flexirol Multidirectional Glass 135	4000mm	1000mm per 100kg of glass	1200mm	10mm or 12mm	250kg/500kg*

\*System can cater for doors weighing up to 250kg when using one hanger or 500kg when using two hangers

## Product Specification

Component	Description	Flexirol MD Glass 90 Short Code	Flexirol MD Glass 135 Short Code
Track	White aluminium track available in 2000, 3000, 4000, 5000 and 6000mm lengths	550/****	550/****
	Aluminium mill finish track available in 2000, 3000, 4000, 5000 and 6000mm lengths	550/****M	550/****M
Brackets	Face fixed bracket	1A/550	1A/550
	Soffit fixed bracket - suspended ceiling	3S/550	3S/550
Hangers	90° or 135° hanger	555	556
Glass Profile	Top and bottom glass profile	FRP02	FRP02
Pivots	Pivot set	21/550GP	21/550GP

\*\*\*\* replace by length of track for full short code.

### FLEXIROL MULTIDIRECTIONAL 90

Multidirectional door

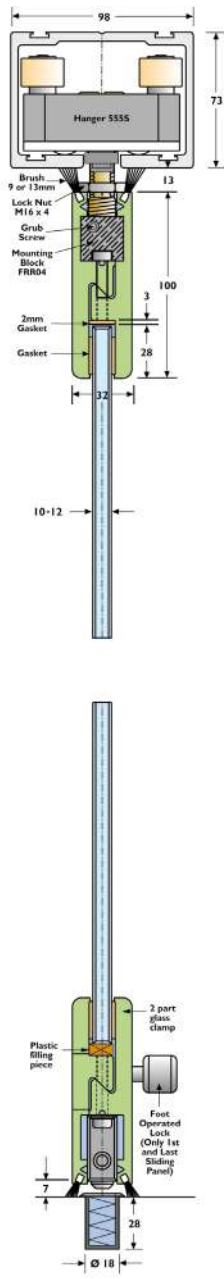

Swing door

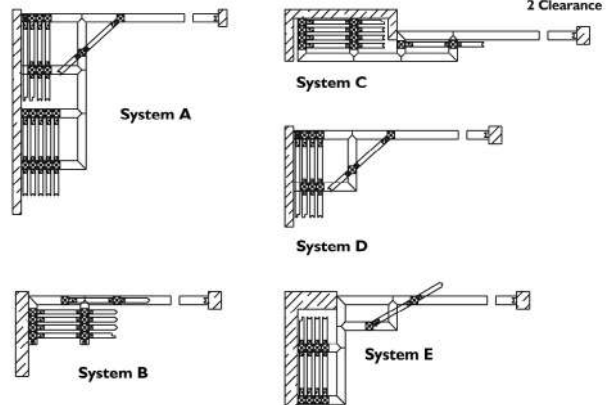
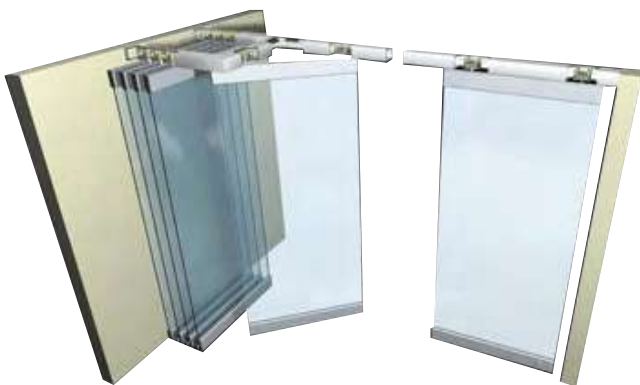
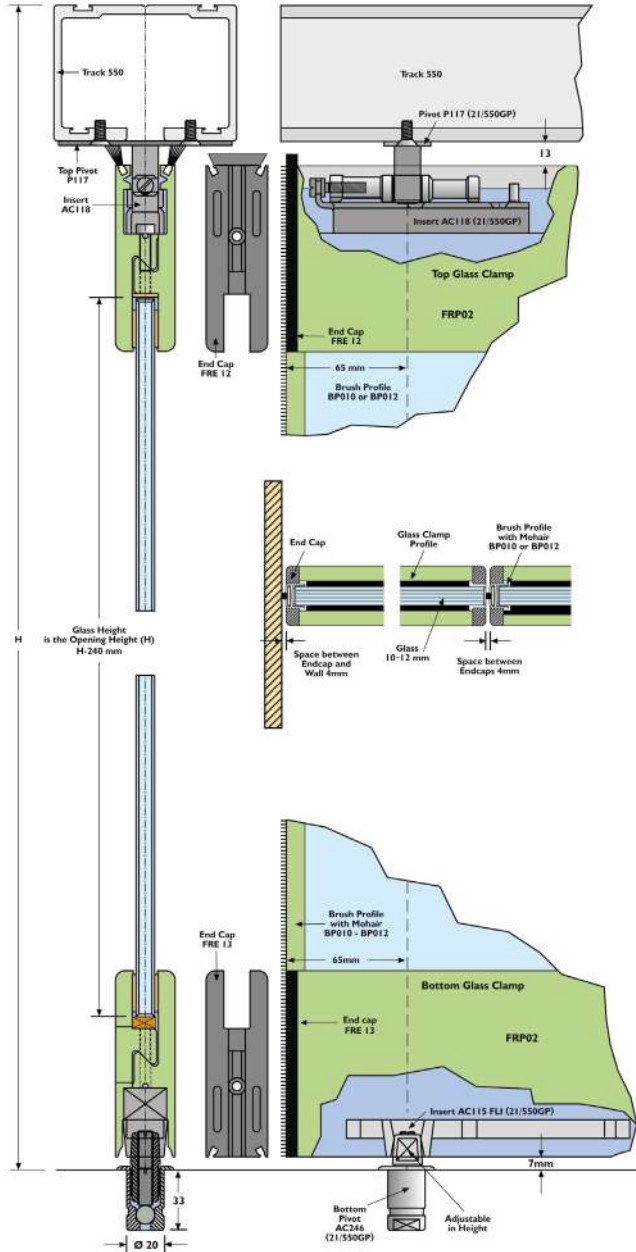



**FLEXIROL MULTIDIRECTIONAL 135**

**Multidirectional door**

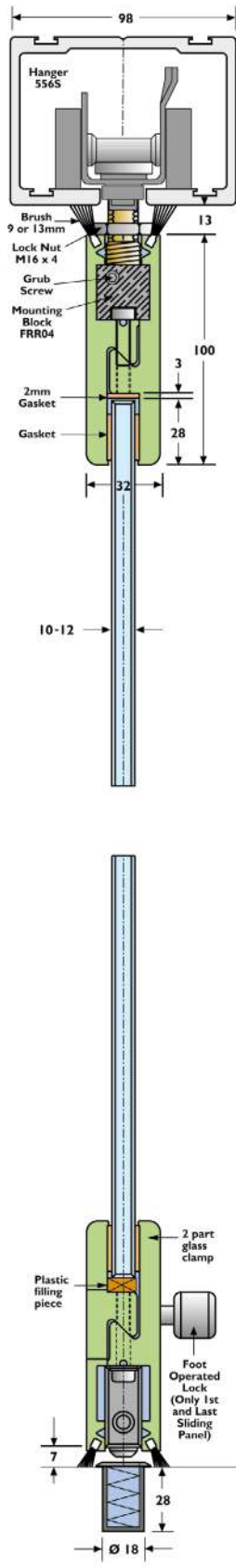

**Swing door**

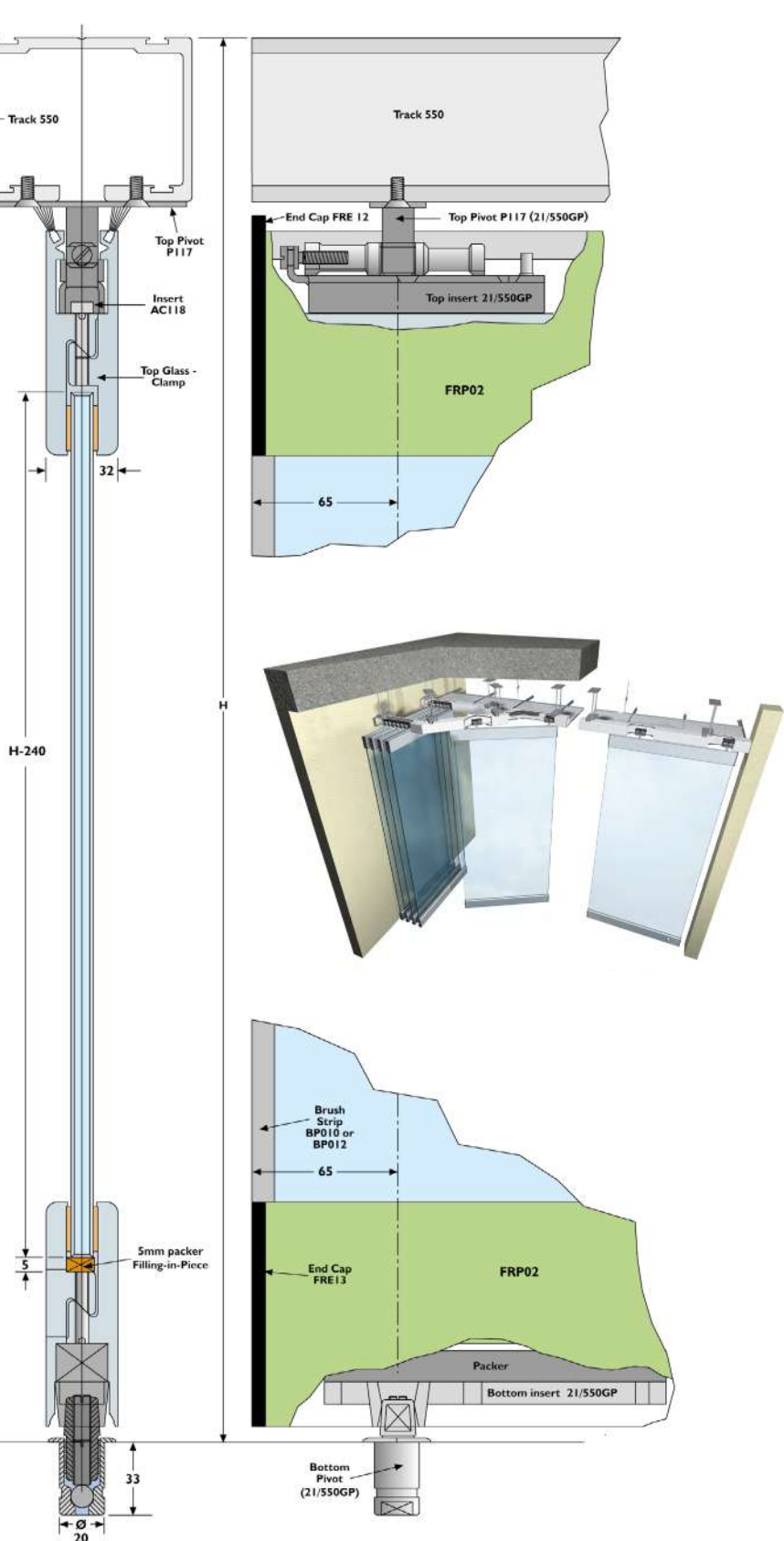

For standard layouts please see page 101.

# Round the Corner



A robust range of top hung systems for round the corner applications where a unit of stacked doors would be impractical or unsuitable. Our round-the-corner range is suitable for maximum door weights of between 35kg and 70kg and can cater for wooden or metal doors.

Ideally suited for residential garages, commercial and light industrial applications, the system works whereby the doors slide around the corner, clear of the opening, and park along the adjacent side walls. Offering further flexibility the doors can slide to one or both sides of the opening.

## Range Overview

- Catering for maximum door weights of up to 35kg and 70kg
- Suitable for wooden or metal doors
- Exterior applications
- Doors rest on adjacent wall
- Ideal solution for where a unit of stacked doors is unsuitable

# TANGENT ROUND THE CORNER

Top-hung door system for round the corner applications



Tangent Round the Corner is a robust top hung door system for round the corner residential, commercial or light industrial wooden or metal doors. The doors may be panelled, flushed or glazed and can weigh up to 35kg, 55kg or 70kg each. The system is particularly suited where a bunched unit of parked panels would be impractical.

Only 3 to 5 panels should be hinged in 1 unit, but any number of units may be used to suit panels from a minimum of 711mm to a maximum of 900mm



## Product Information

Product	Max. Door Height	Min. Door Width	Max. Door Width	Door Thickness Range	Max. Door Weight
Tangent RTC 290	2400mm	711mm	900mm	35 - 50mm	35kg
Tangent RTC 301	3300mm	711mm	900mm	45 - 55mm	55kg
Tangent RTC 301H	3600mm	711mm	900mm	45 - 55mm	70kg

## Product Specification

Component	Description	290 Short Code	301 Short Code
Track	Available in 2000, 2500, 3000, 4000 and 6000mm lengths	290/****	301/****
Track Curves	Require 1 or 2 for bi-parting doors	600K	600B
Brackets Fix every 900mm max and at track joints and curves. Fix jointing brackets/sleeve at both curved ends.	Face fixed bracket	1A/290	1A/301
	Face fixed jointing bracket	1AX/290	4RX/301TS or 1AX/301
Hangers 1 per door joint and end door	Intermediate hanger	62K	62A
	End hanger	63K	63A
Hinges 3 in height	Backflap hinge	65	65
	Intermediate guide	67/89	67/97
Guides 1 per door joint and end door	End Guide	68/89	68/97
	Channel	Galvanised steel channel available in 2000, 2500, 3000, 4000 and 6000mm lengths	89/****

\*\*\*\* replace by length of track for full short code.

## SECTION DETAILS

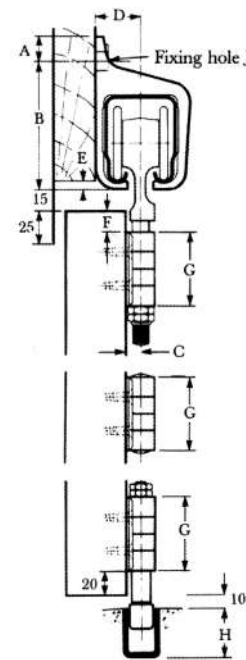
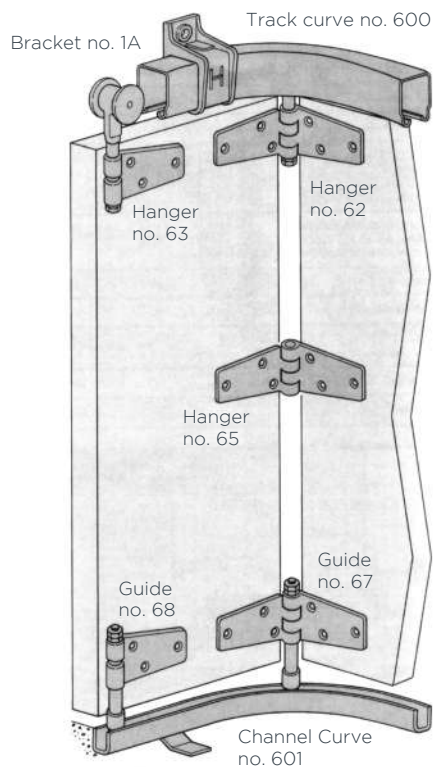

## Dimensions

Track	A	B	C	D	E	F	G	H	J	K	L
290	13	67	11	27	6	10	57	25	M8	6	65
301/301H	20	97	11	35	6	15	57	25	M12	16	70

## CHOICE OF GEARS

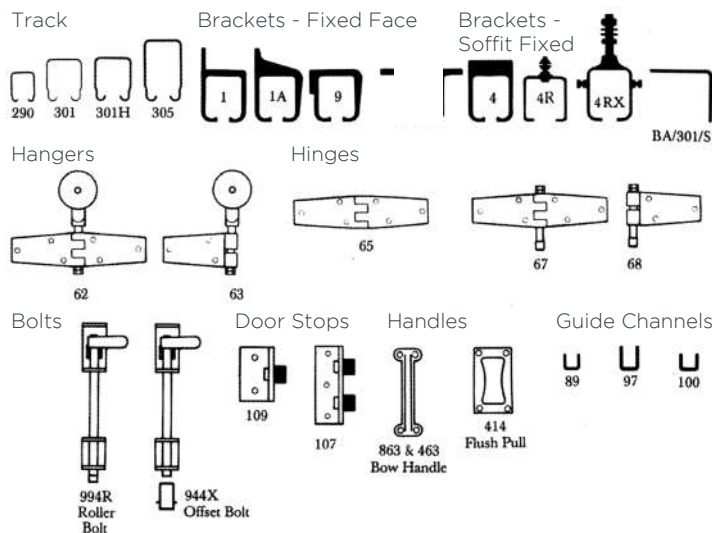

## EXAMPLE PLAN DETAILS



For convenient locking R should not exceed 360mm, but 115mm-230mm is ideal. If the swingleaf under the curve is not required R should be a min of 690mm to accommodate the corner curve

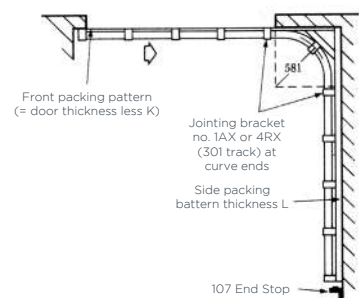

## Accessories



Roller Bolt 380mm for 89 Channel (**994R/89**)



Roller Bolt 380mm for 97 Channel (**994R/97**)



Galvanised Steel Offset Shoot Bolt (**994X**)

View our full range of door handles and flush pulls on pages 130 and 131.





# Automated



Evolve is an exceptionally convenient and highly sophisticated range of automatic sliding systems that can be used in any domestic or light commercial environment.

Designed to further enhance our sliding range of products, Evolve hardware features a built in system that enables sliding doors to open at the push of a button, remote control or by activation of a movement sensor.

Available to cater for single doors or two bi-parting doors with simultaneous action, the system offers the utmost in ease and sophistication as well as being an ideal solution for those living with mobility access needs.

## Range Overview

- Catering for maximum door weights of up to 80kg
- Sliding doors open at the push of a button, remote control or by activation of a movement sensor
- Available in single or bi-parting door options
- Suitable for wooden and glass doors
- Interior applications

# EVOLVE

Automated sliding system for wooden and glass doors weighing up to 80kg



Featuring a more sophisticated track and a quieter motor, our new and improved Evolve system now incorporates our popular Soltaire 120 system. The result is an exceptionally smooth and reliable automated system which can cater for single doors or two bi-parting door with simultaneous action.

Sliding doors can open at the push of a button, remote control or by activation of a movement sensor – offering the utmost in sophistication and convenience.

Evolve is an ideal solution to improve mobility access or add a sophisticated feature to a home or workplace. Evolve comes complete with track, hangers, floor guide, track stops, automated kit and two wall mounted control panels as standard. A number of sophisticated optional extras are available that can add to the refinement of the product.

## Product Information

Short Code	Type of System	Door Material	Track Length	Door/Glass Thickness Range	Min. Door Width	Max. Door Width	Max. Door Weight
E80/20	Single Door	Wood	2000mm	30 - 50mm*	675mm	1100mm**	80kg
E80/30	Single Door	Wood	3000mm	30 - 50mm*	675mm	1600mm***	80kg
10/E80/20	Single Door	Glass	2000mm	10mm	760mm	1100mm**	80kg
10/E80/30	Single Door	Glass	3000mm	10mm	760mm	1600mm***	80kg
12/E80/20	Single Door	Glass	2000mm	12mm	760mm	1100mm**	80kg
12/E80/30	Single Door	Glass	3000mm	12mm	760mm	1600mm***	80kg
ESIM80/40	Bi-Parting Doors	Wood	4000mm (2 x 2000mm)	30 - 50mm*	675mm	1058mm****	40kg (per door)
10/E80SIM/40	Bi-Parting Doors	Glass	4000mm (2 x 2000mm)	10mm	760mm	1058mm****	40kg (per door)
12/E80SIM/40	Bi-Parting Doors	Glass	4000mm (2 x 2000mm)	12mm	760mm	1058mm****	40kg (per door)

\*A spacer is required to accommodate doors over 40mm in a wooden door face fixed application

\*\* Clear opening is 1020mm \*\*\*Clear opening is 1520mm \*\*\*\*Clear opening is 2035mm

## Kit Contents

Track (120/2000 or 120/3000)

Hangers (51/120/SS) or Glass Clamps

Floor Guide (101SS or 8-12/SN)

Track Stops (HH4/SS)

Toothed Belt

Belt Clamp

Tension Wheel

Face Fixed Brackets

Motor (1.5m cable length)

24V Transformer

Wall Mounted Control Panels x2



### Wooden Door Application

### Glass Door Application

OH = OPENING HEIGHT  
 TC = TOP CLEARANCE  
 BC = BOTTOM CLEARANCE  
 P = PADDER

B = DOOR THICKNESS  
 TSH = TRACK SET HEIGHT  
 X = OVERLAP PCH  
 RECOMMEND 13mm

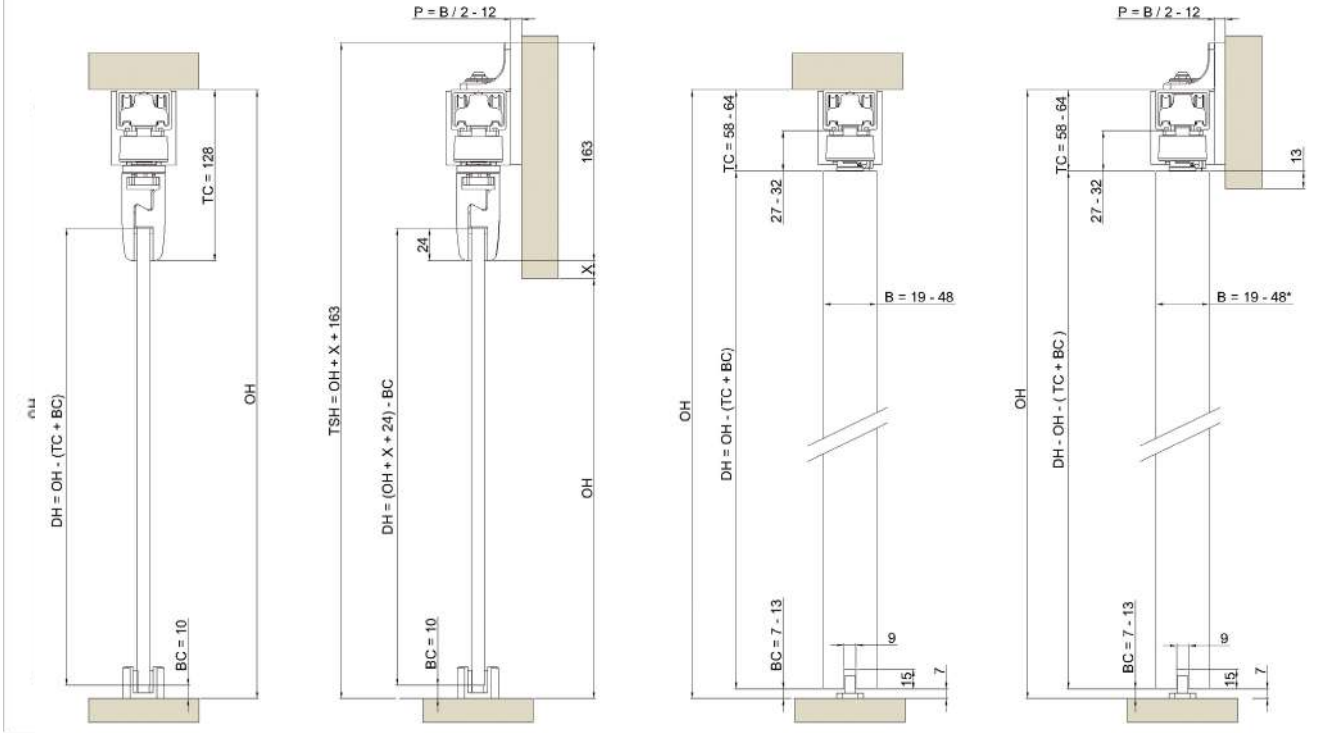

### Single Door Application

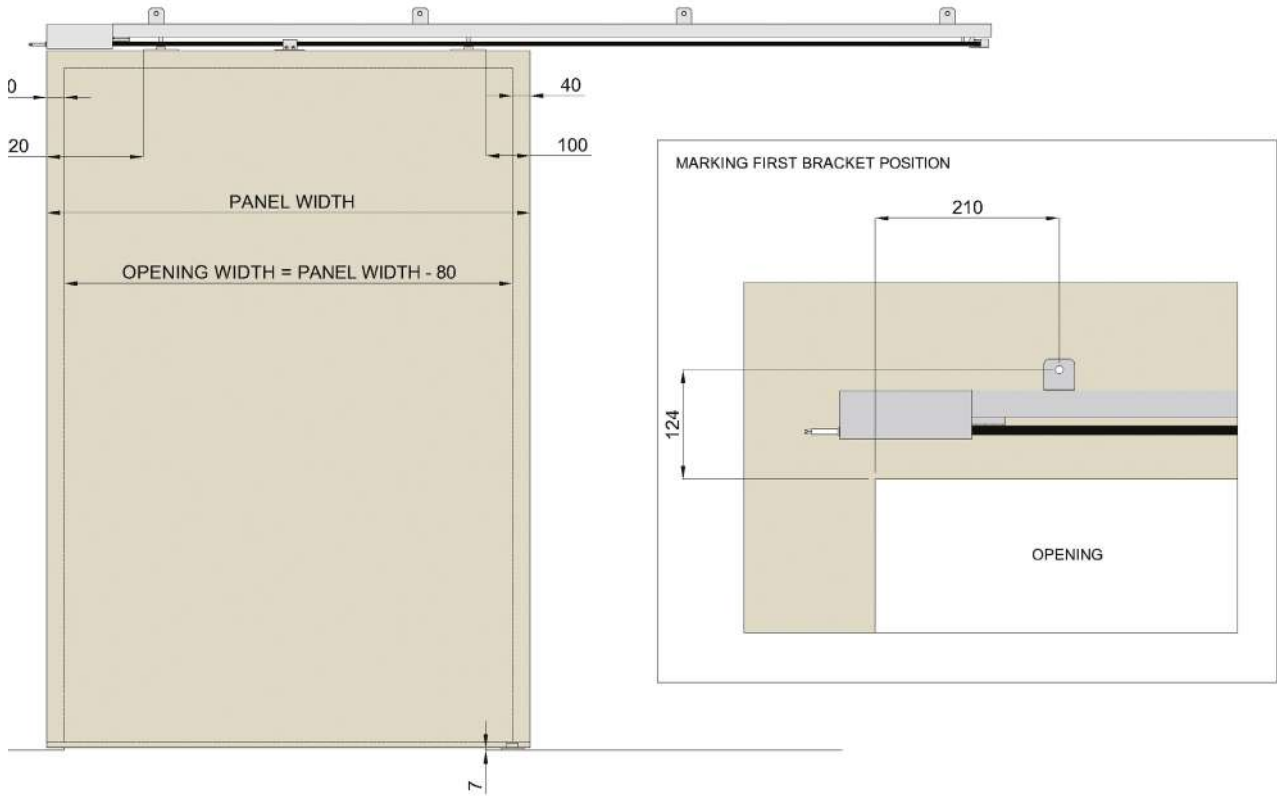



# EVOLVE CONTINUED



## Accessories



**Remote Control Kit (E2/RCK)**  
Includes a single channel remote control and one wireless receiver control panel



**Radar Motion Sensor (ER/\*)**  
Available in black (ER/B), white (ER/W) or aluminium (ER/S)

**View our full range of door handles and flush pulls and flush bolts on pages 128 and 129.**

# Door Configurations and Quantities

## Folding Doors

Folding door units consist of a number of wooden or aluminium doors hinged together. Wide units usually slide and fold in two parts, to the right and left. Extra wide openings should be covered by three or more units with the centre units floating.

## Brackets

The space between brackets should be a maximum of 500mm. A bracket must be fixed 50mm from each end of the track. An additional bracket should be fixed above the stacking area (e.g. above the doors when the system is in the open position).

## Fittings

Having selected the track, extract the fittings and quantities shown in the relative column. Sidewall or soffit fixed brackets are available.



## Track

Select the track according to the height of weight per leaf.

Securefold door configurations can be found on page 96 and 97 and Securefold Bottom Rolling door configurations can be found on page 79.

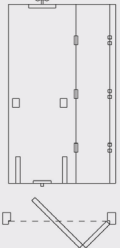
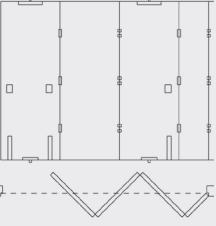

## Interior Centre Folding Systems

Configuration	Item	Quantity	Component		
			2700mm Door Height or 35kg Max. Door Weight	2700mm Door Height or 75kg Max. Door Weight	4500mm Door Height or 125kg Max. Door Weight
<b>1.5 LEAF</b> Centre folding hinged to post  <p>*For doors exceeding 3000mm high increase to 8</p>	Track	-	600	600	550
	Brackets	See notes	1B	1B	1A/550 or 3S/550
	Hanger	1	61B	61B/4	556/61
	Hinges	6*	403 (89x50)	403 (100x55)	403 (100x75)
	Guide	1	106N	106N	106N
	Channel	-	94 or 94X	94 or 94X	94 or 94X
	Flushpull	2	400	400	400
	Flushbolt	2	SF190/450/600 or F3715 and F3734	SF190/450/600 or F3715 and F3734	SF190/450/600 or F3715 and F3734
<b>3.5 LEAF</b> Centre folding hinged to post  <p>*For doors exceeding 3000mm high increase to 16</p>	Track	-	600	600	550
	Brackets	See notes	1B	1B	1A/550 or 3S/550
	Hanger	2	61B	61B/4	556/61
	Hinges	12*	403 (89x50)	403 (100x55)	403 (100x75)
	Guide	2	106N	106N	106N
	Channel	-	94 or 94X	94 or 94X	94 or 94X
	Flushpull	3	400	400	400
	Flushbolt	3	SF190/450/600 or F3715 and F3734	SF190/450/600 or F3715 and F3734	SF190/450/600 or F3715 and F3734
<b>5.5 LEAF</b> Centre folding hinged to post  <p>*For doors exceeding 3000mm high increase to 24</p>	Track	-	600	600	550
	Brackets	See notes	1B	1B	1A/550 or 3S/550
	Hanger	3	61B	61B/4	556/61
	Hinges	18*	403 (89x50)	403 (100x55)	403 (100x75)
	Guide	3	106N	106N	106N
	Channel	-	94 or 94X	94 or 94X	94 or 94X
	Flushpull	4	400	400	400
	Flushbolt	4	SF190/450/600 or F3715 and F3734	SF190/450/600 or F3715 and F3734	SF190/450/600 or F3715 and F3734
<b>5 LEAF</b> Centre folding hinged to post  <p>*For doors exceeding 3000mm high increase to 16</p>	Track	-	600	600	550
	Brackets	See notes	1B	1B	1A/550 or 3S/550
	Hanger	3	61B	61B/4	556/61
	Hinges	12*	403 (89x50)	403 (100x55)	403 (100x75)
	Guide	3	106N	106N	106N
	Channel	-	94 or 94X	94 or 94X	94 or 94X
	Flushpull	2	400	400	400
	Flushbolt	2	SF190/450/600 or F3715 and F3734	SF190/450/600 or F3715 and F3734	SF190/450/600 or F3715 and F3734

## Interior End Folding Systems

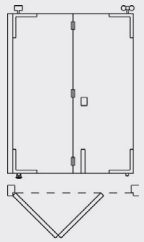
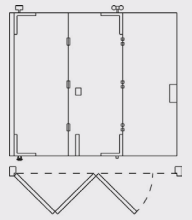
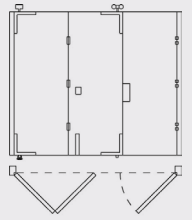
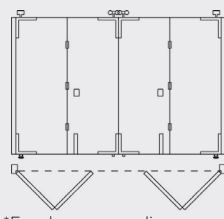
Configuration	Item	Quantity	Component	
			2700mm Door Height or 35kg Max. Door Weight	4500mm Door Height or 35kg Max. Door Weight
<b>2 LEAF</b> Folding to the left 	Track	-	600	550
	Brackets	See notes	1B	3S/550
	Hanger	1	21B	556/21
	Pivot	1	21B/P	21/550P
	Hinges	3*	403 (89x50)	403 (100x75)
	Guide	1	21N/94	21R/94
	Channel	-	94 or 94X	94 or 94X
	Flushpull	1	400	400
	Flushbolt	1	SF190/450/600 or F3715 and F3734	SF190/450/600 or F3715 and F3734
	Lock and handles	1	-	-
<b>3 LEAF</b> With swinger folding to the left 	Track	-	600	550
	Brackets	See notes	1B	3S/550
	Hanger	1	21B/4	556/21
	Pivot	1	21B/P	21/550P
	Hinges	6*	403 (89x50)	403 (100x75)
	Guide	1	21N/94	21R/94
	Channel	-	94 or 94X	94 or 94X
	Flushpull	1	400	400
	Flushbolt	2	SF190/450/600 or F3715 and F3734	SF190/450/600 or F3715 and F3734
	Lock and handles	1	-	-
<b>3 LEAF</b> 2 folding to the left, 1 swinger hinged to post 	Track	-	600	550
	Brackets	See notes	1B	3S/550
	Hanger	1	21B	556/21
	Pivot	1	21B/P	21/550P
	Hinges	6*	403 (89x50)	403 (100x75)
	Guide	1	21N/94	21R/94
	Channel	-	94 or 94X	94 or 94X
	Flushpull	-	400	400
	Flushbolt	1	SF190/450/600 or F3735	SF190/450/600 or F3735
	Lock and handles	1	-	-
<b>4 LEAF</b> 2 folding to each side 	Track	-	600	550
	Brackets	See notes	1B	3S/550
	Hanger	2	21B	556/21
	Pivot	2	21B/P	21/550P
	Hinges	6*	403 (89x50)	403 (100x75)
	Guide	2	21N/94	21R/94
	Channel	-	94 or 94X	94 or 94X
	Flushpull	2	400	400
	Flushbolt	2	SF190/450/600 or F3715 and F3734	SF190/450/600 or F3715 and F3734
	Lock and handles	1	-	-

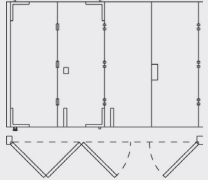
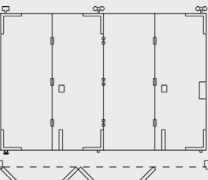
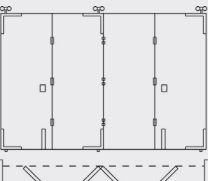
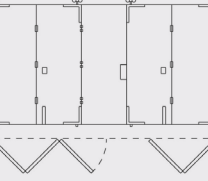

## Interior End Folding Systems

Configuration	Item	Quantity	Component		
			2700mm Door Height or 35kg Max. Door Weight	4500mm Door Height or 35kg Max. Door Weight	
<b>4 LEAF</b> 3 with swinger to the left, 1 separate hinged to post 	Track	-	600	550	
	Brackets	See notes	1B	3S/550	
	Hanger	1	21B/4	556/21	
	Pivot	1	21B/P	21/550P	
	Hinges	9*	403 (89x50)	403 (100x75)	
	Guide	1	21N/94	21R/94	
	Channel	-	94 or 94X	94 or 94X	
	Flushpull	1	400	400	
	Flushbolt	2	SF190/450/600 or F3715 and F3734	SF190/450/600 or F3715 and F3734	
	Lock and handles	1	-	-	
	<b>4 LEAF</b> Folding to the left 	Track	-	600	550
Brackets		See notes	1B	3S/550	
Hanger		2	21B	556/21	
Pivot		1	21B/P	21/550P	
Hinges		9*	403 (89x50)	403 (100x75)	
Guide		2	21N/94	21R/94	
Channel		-	94 or 94X	94 or 94X	
Flushpull		2	400	400	
Flushbolt			SF190/450/600 or F3715 and F3734	SF190/450/600 or F3715 and F3734	
Lock and handles		1	-	-	
<b>4 LEAF</b> Floating 		Track	-	600	550
	Brackets	See notes	1B	3S/550	
	Hanger	3	21B	556/21	
	Hinges	9*	403 (89x50)	403 (100x75)	
	Guide	3	21N/94	21R/94	
	Channel	-	94 or 94X	94 or 94X	
	Flushpull	2	400	400	
	Flushbolt	2	SF190/450/600 or F3715 and F3734	SF190/450/600 or F3715 and F3734	
	Lock and handles	1	-	-	
	<b>5 LEAF</b> 3 to the right with swinger, 2 to the left 	Track	-	600	550
Brackets		See notes	1B	3S/550	
Hanger		2	21B	556/21	
Pivot		2			
Hinges		9*	403 89x50	403 100x75	
Guide		2	21N/94	21R/94	
Channel		-	94 or 94X	94 or 94X	
Flushpull		2	400	400	
Flushbolt		2	SF190/450/600 or F3715 and F3734	SF190/450/600 or F3715 and F3734	
Lock and handles		1	-	-	

## Interior End Folding Systems

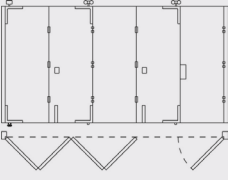
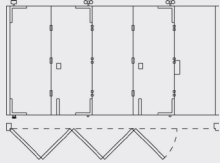
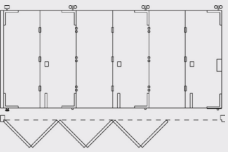
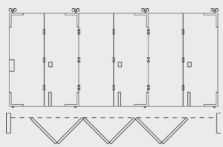
Configuration	Item	Quantity	Component	
			2700mm Door Height or 35kg Max. Door Weight	4500mm Door Height or 35kg Max. Door Weight
<b>5 LEAF</b> 4 to the right, 1 separate swinger  <p>*For doors exceeding 3000mm high increase to 16</p>	Track	-	600	550
	Brackets	See notes	1B	3S/550
	Hanger	2	21B	556/21
	Pivot	1	21B/P	21/550P
	Hinges	12*	403 (89x50)	403 (100x75)
	Guide	2	21N/94	21R/94
	Channel	-	94 or 94X	94 or 94X
	Flushpull	2	400	400
	Flushbolt	2	SF190/450/600 or F3715 and F3734	SF190/450/600 or F3715 and F3734
	Lock and handles	1	-	-
	<b>5 LEAF</b> With swinger  <p>*For doors exceeding 3000mm high increase to 16</p>	Track	-	600
Brackets		See notes	1B	3S/550
Hanger		2	21B	556/21
Pivot		1	21B/P	21/550P
Hinges		12*	403 (89x50)	403 (100x75)
Guide		2	21N/94	21R/94
Channel		-	94 or 94X	94 or 94X
Flushpull		2	400	400
Flushbolt		2	SF190/450/600 or F3715 and F3734	SF190/450/600 or F3715 and F3734
Lock and handles		1	-	-
<b>6 LEAF</b> Folding  <p>*For doors exceeding 3000mm high increase to 20</p>		Track	-	600
	Brackets	See notes	1B	3S/550
	Hanger	3	21B	556/21
	Pivot	1	21B/P	21/550P
	Hinges	15*	403 (89x50)	403 (100x75)
	Guide	3	21N/94	21R/94
	Channel	-	94 or 94X	94 or 94X
	Flushpull	3	400	400
	Flushbolt	3	SF190/450/600 or F3715 and F3734	SF190/450/600 or F3715 and F3734
	Lock and handles	1	-	-
	<b>6 LEAF</b> "Floating"  <p>*For doors exceeding 3000mm high increase to 20</p>	Track	-	600
Brackets		See notes	1B	3S/550
Hanger		4	21B	556/21
Hinges		15*	403 (89x50)	403 (100x75)
Guide		4	21N/94	21R/94
Channel		-	94 or 94X	94 or 94X
Flushpull		3	400	400
Flushbolt		3	SF190/450/600 or F3715 and F3734	SF190/450/600 or F3715 and F3734
Lock and handles		1	-	-

## Interior End Folding Systems

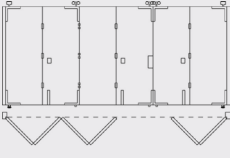
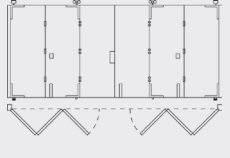
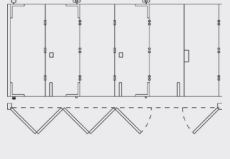
Configuration	Item	Quantity	Component	
			2700mm Door Height or 35kg Max. Door Weight	4500mm Door Height or 35kg Max. Door Weight
<b>6 LEAF</b> 4 folding to the left, 2 folding to the right 	Track	-	600	550
	Brackets	See notes	1B	3S/550
	Hanger	3	21B	556/21
	Pivot	2	21B/P	21/550P
	Hinges	12*	403 (89x50)	403 (100x75)
	Guide	3	21N/94	21R/94
	Channel	-	94 or 94X	94 or 94X
	Flushpull	3	400	400
	Flushbolt	3	SF190/450/600 or F3715 and F3734	SF190/450/600 or F3715 and F3734
	Lock and handles	1	-	-
	*For doors exceeding 3000mm high increase to 16			
<b>6 LEAF</b> 3 with swinger to the left, 3 with swinger to the right 	Track	-	600	550
	Brackets	See notes	1B	3S/550
	Hanger	2	21B	556/21
	Pivot	2	21B/P	21/550P
	Hinges	12*	403 (89x50)	403 (100x75)
	Guide	2	21N/94	21R/94
	Channel	-	94 or 94X	94 or 94X
	Flushpull	3	400	400
	Flushbolt	3	SF190/450/600 or F3715 and F3734	SF190/450/600 or F3715 and F3734
	Lock and handles	1	-	-
	*For doors exceeding 3000mm high increase to 16			
<b>6 LEAF</b> 5 with swinger to the left, 1 separate swinger 	Track	-	600	550
	Brackets	See notes	1B	3S/550
	Hanger	2	21B	556/21
	Pivot	1	21B/P	21/550P
	Hinges	15*	403 (89x50)	403 (100x75)
	Guide	2	21N/94	21R/94
	Channel	-	94 or 94X	94 or 94X
	Flushpull	2	400	400
	Flushbolt	3	SF190/450/600 or F3715 and F3734	SF190/450/600 or F3715 and F3734
	Lock and handles	1	-	-
	*For doors exceeding 3000mm high increase to 20			

# Component Drawings

Detailed drawings and dimensions of our range of commercial tracks, intersects, curves, brackets, hangers, pivot sets, guides, guide channels, accessories and stops. Industrial component drawings can be found on page 122.

## Track, Intersect and Curve Drawings

280A Track

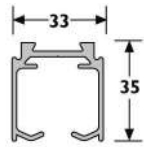

600 Track

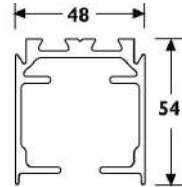

550 Track

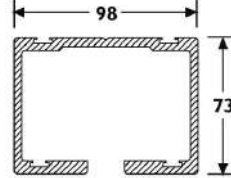

45R/550 Intersect (Top View)

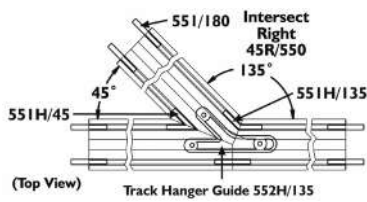

45L/550 Intersect (Top View)

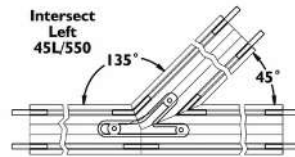

H135/550 Intersect (Top View)

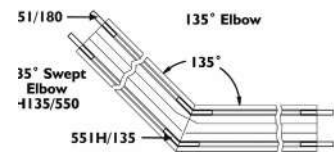

H90C/550 Intersect (Top View)

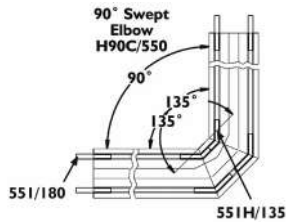

H90/550 Intersect

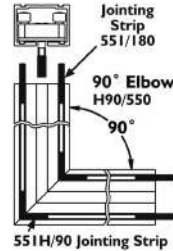

Intersect

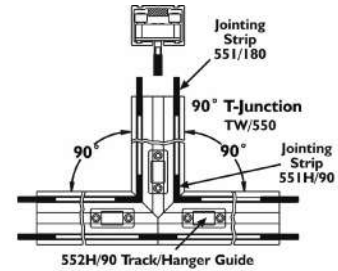

## Bracket Drawings

1B

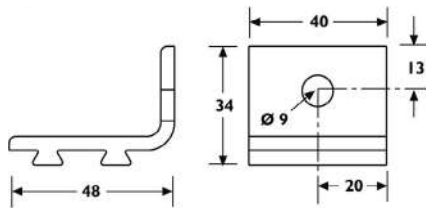

1BX

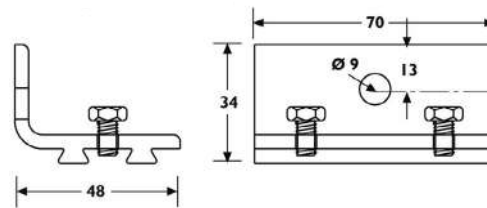

1A/550

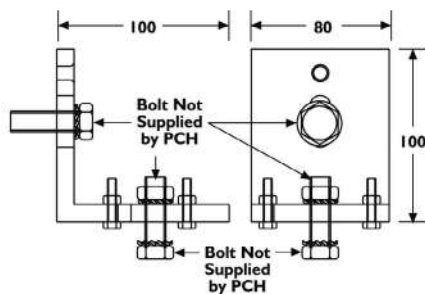

3S/550

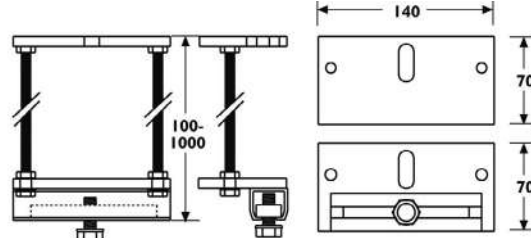

281AN

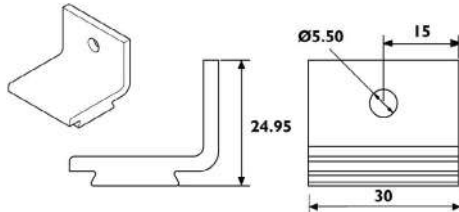

281AX

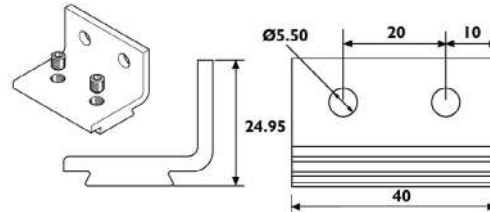



# Hanger Drawings

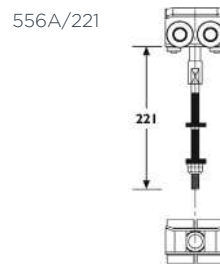
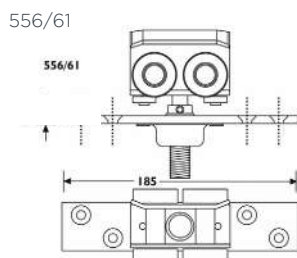
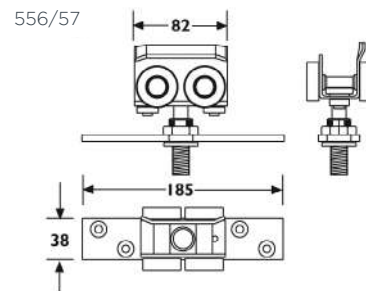
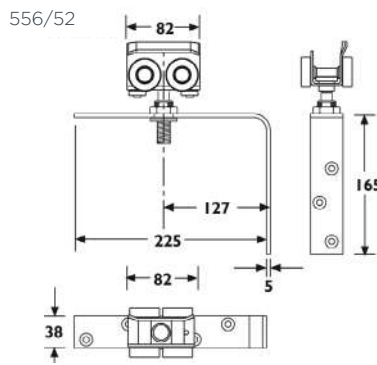
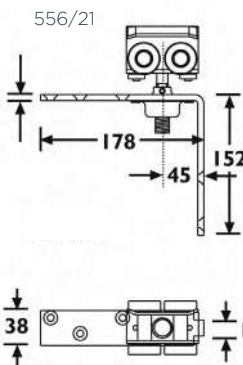
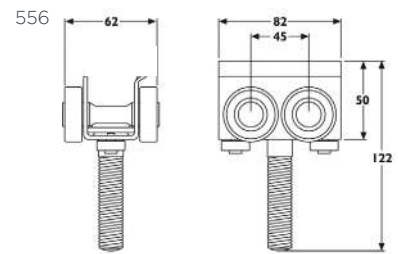
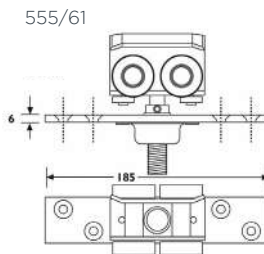
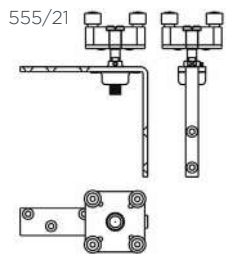
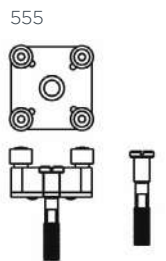
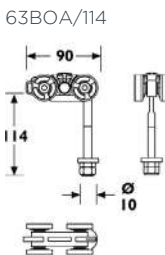
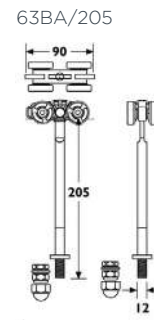
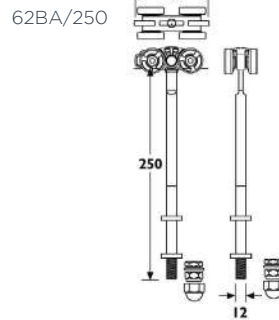
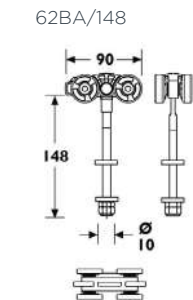
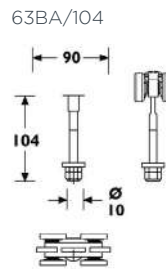
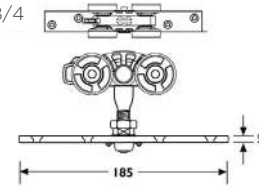
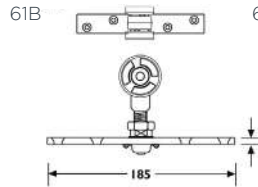
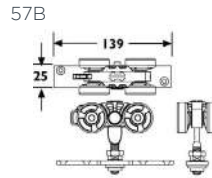
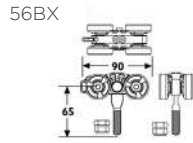
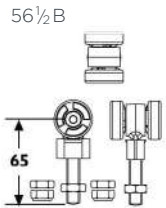
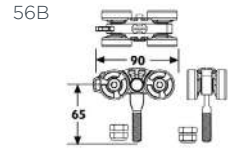
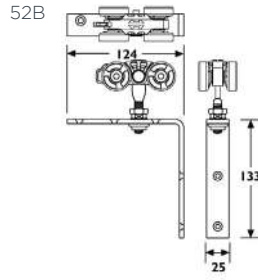
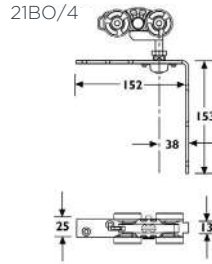
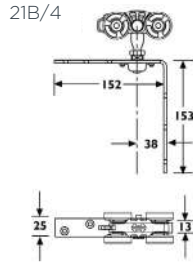
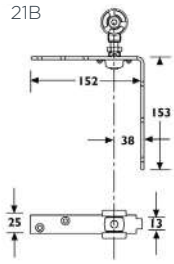

## Pivot Set Drawings

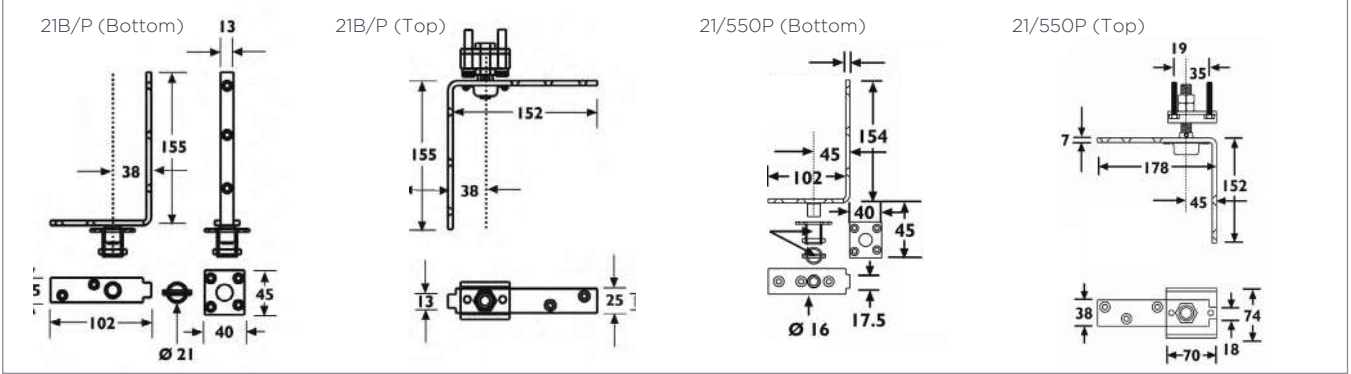

## Guide Drawings

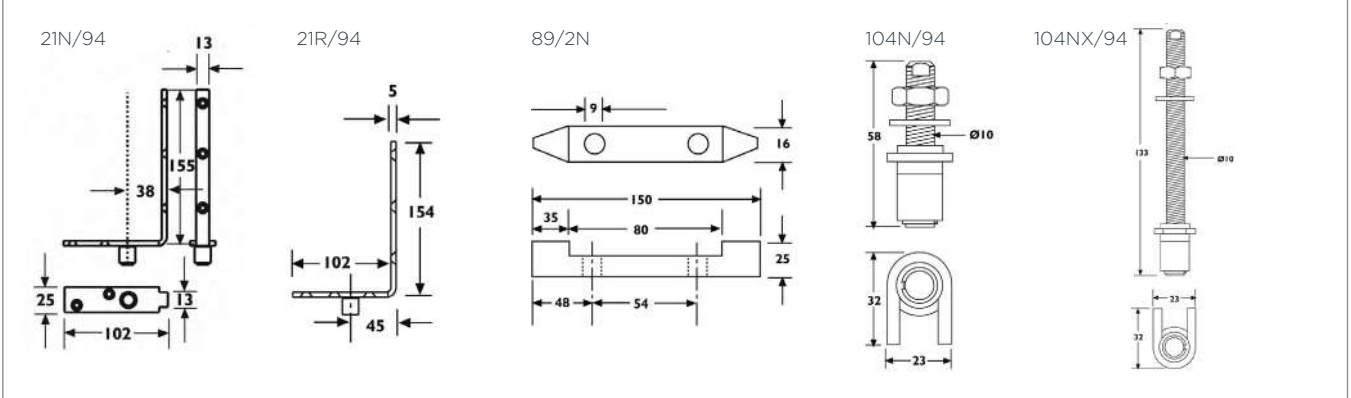

## Guide Channel Drawings

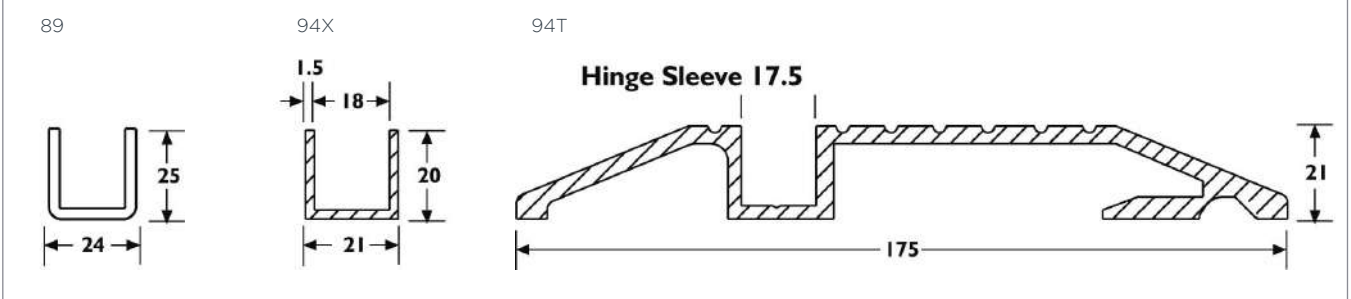

## Accessories and Stops

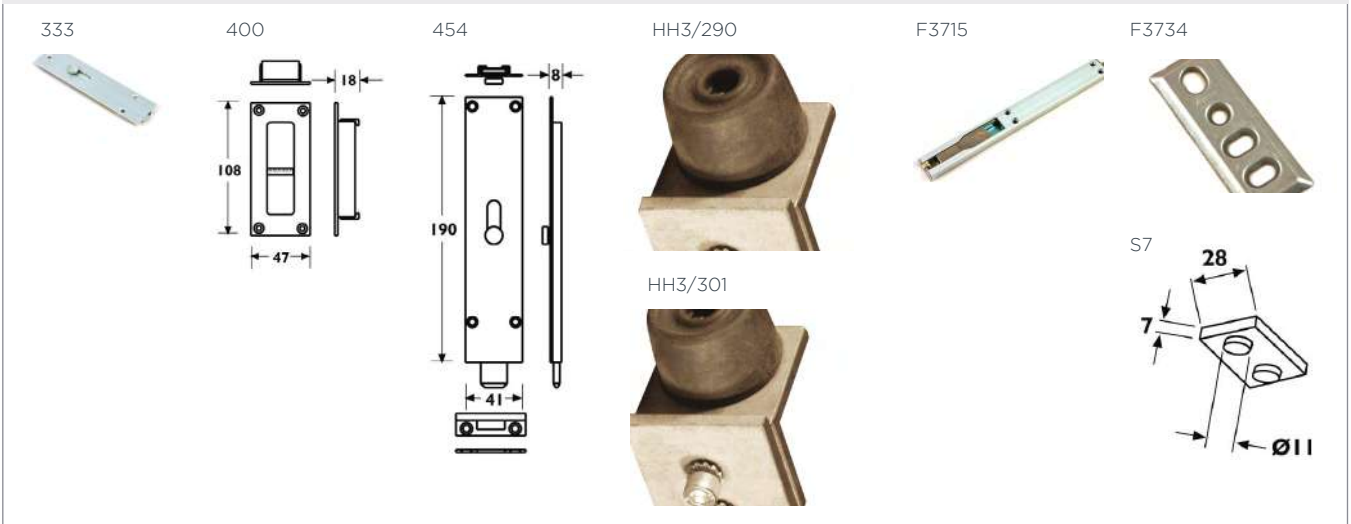

# Industrial Component Drawings

Detailed drawings and dimensions of our range of industrial tracks, brackets, hangers, channels and rails.

## Industrial products include:

- College Centrefold
- College Endfold
- Council Centrefold
- Council Endfold
- Majestic
- Mansion
- Overhead Runway Gear
- Sterling
- Straight Sliding
- Tangent Folding
- Tangent Round the Corner
- Versaframe

## Industrial Track Drawings

All of our industrial tracks are in a galvanised finish excluding the 307 track which is zinc plated. Once installed, the tracks require minimal maintenance but should always be kept greased in order to reduce general wear and tear and to obtain the most optimum lifespan for the product. Any length of track can be obtained by simply putting sections of track together and fixing together with a jointing bracket, complete with end clips or closed brackets at each end.



# Industrial Bracket Drawings

All brackets are aluminium alloy die casting except where indicated with a suffix /S in the short code e.g. 1/301/S which are zinc plated steel. Ensure that closed brackets are fitted with an end-clip at track ends. Jointing brackets are required at each track joint and maximum bracket spacing is every 900mm.

## Face Fixed

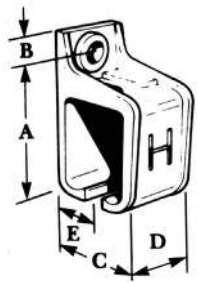

1 and 1A						
Short Code	Dimensions					Bolt
	A	B	C	D	E	
1A/290	67	13	52	32	27	M8
1/290/S	75	13	55	60	27	M8
1A/301	97	19	73	57	35	M12
1/301/S	95	16	69	60	37	M12
1A/305	140	25	85	76	38	M16
1/307/S	159	24	91	75	45	M16



Note: Bracket End Clips 1A/290EC and 1A/301EC can be used in order to convert brackets 1, 1A, 3A, 4A, 5, 5AA and 6/301 to closed brackets (290, 301 and 301H formats only).

1/301/S steel bracket is fully also accepts the 1A/301EC end clips.

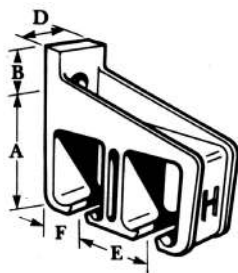

5						
Short Code	Dimensions					Bolt
	A	B	C	D	E	
5/290	80	20	38	54	27	M12
5/301	110	33	57	79	39	M16
5/305	155	38	75	92	48	M20
5/307/S	192	26	102	91	45	M20

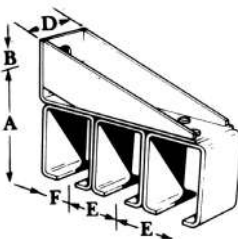

7						
Short Code	Dimensions					Bolt
	A	B	C	D	E	
7/301/S	116	38	60	66	40	M16



9 and 9A						
Short Code	Dimensions					Bolt
	A	B	C	D	E	
9A/290	43	16	70	24	51	14G Screw
9/301/S	65	12	125	38	89	18G Screw
9/305/S	84	38	160	59	130	M12
9/307/S	84	50	184	69	140	M16

## Soffit Fixed

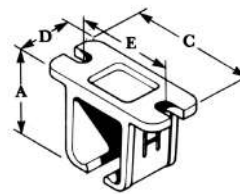

3 and 3A						
Short Code	Dimensions					Bolt
	A	B	C	D	E	
3A/290	56	-	83	32	64	M8
3A/301	86	-	130	57	100	M12
3/301/S	88	-	130	57	97	M12
3A/305	121	-	168	75	125	M16
3/307/S	158	-	184	90	140	M16

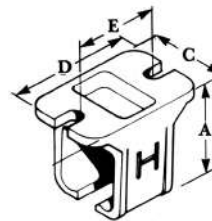

4 and 4A						
Short Code	Dimensions					Bolt
	A	B	C	D	E	
4A/290	67	-	48	75	60	M8
4A/301	95	-	75	117	95	M12
4A/305	137	-	83	190	130	M16
4/307/S	158	-	91	184	140	M16

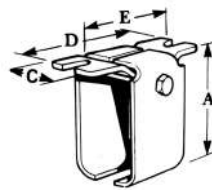

4/301/S						
Short Code	Dimensions					Bolt
	A	B	C	D	E	
4A/301/S	94	-	45	117	95	M12

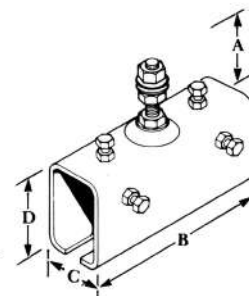

4R						
Short Code	Dimensions				Bolt	
	A	B	C	D		
4R/290/S	46	30	44	53	M10	
4R/301/S	66	57	65	78	M12	
4R/305/S	68	75	71	107	5/8White	
4RX/301TS	70	145	64	70	M12	

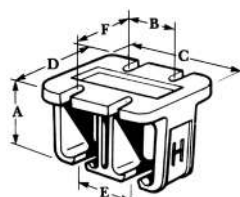

6							
Short Code	Dimensions					Bolt	
	A	B	C	D	E		
6/301	95	79	152	127	79	92	M10

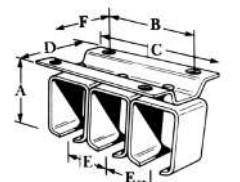

8							
Short Code	Dimensions					Bolt	
	A	B	C	D	E		
8/301/S	98	127	178	118	66	92	M12



# Industrial Hanger Drawings

Our range of industrial hangers include both nylon wheeled (/N) and steel wheeled (/S) variants. Nylon wheels are more quiet and do not require the track to be greased, therefore allowing for a greater carrying capacity. For automatic doors, please half the carrying capacity and use nylon wheels if possible. Note: Door weight capacities are for a pair of hangers.

## Wood Doors

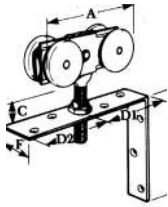

		52						Max. Door Weight
Track	Hanger Short Code	Dimensions						
		A	C	D1	D2	E	F	
290	52K/N							150kg
	52K/S	87	31	77	51	134	25	150kg
	52K/S 200							200kg
301 & 301H	52A/S	142	57	102	127	165	38	300kg
	52A/N							450kg
305	52C/S	161	61	102	127	165	38	700kg

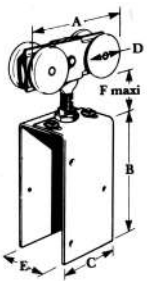

		53						Max. Door Weight
Track	Hanger Short Code	Dimensions						
		A	B	C	D	E	F	
290	53K/N							150kg
	53K/S	87	95	57	37	35-48	30	150kg
	53K/S 200							200kg
301	53A/S	142	178	76	56	43-57	71	300kg
	53A/N							400kg
301H	53A/S	142	178	76	56	43-57	71	360kg
	53A/N							450kg
305	53C/S	161	178	76	75	43-57	71	700kg
307	53FJ/S	215	390	65	88	60	94	2000kg

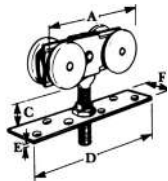

		57						Max. Door Weight
Track	Hanger Short Code	Dimensions						
		A	C	D	E	F		
290	57K/N							150kg
	57K/S 200	87	31	140	5	25		200kg
301	57A/S	142	57	184	6	38		300kg
301H	57A/N	142	57	184	6	38		450kg
305	57C/S	161	61	184	6	38		700kg

## Metal Doors

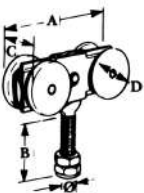

		56						Max. Door Weight
Track	Hanger Short Code	Dimensions						
		A	B	C	D	øD		
290	56K/N							150kg
	56K/S	87	32	27	37	10		150kg
	56K/S 200							200kg
301	56A/S	142	70	42	56	16		300kg
	56A/N							400kg
301H	56A/S	142	70	42	56	16		360kg
	56A/N							450kg
305	56C/S	161	70	42	75	16		700kg
307	56FJ/S	215	86	55	88	20		2000kg

## Metal Doors

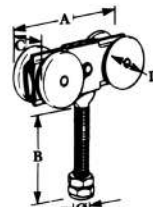

		56x						Max. Door Weight
Track	Hanger Short Code	Dimensions						
		A	B	C	D	øD		
290	56KX/N	87	110	27	37	10		150kg
	56KX/S							200kg
301	56AX/S	142	146	42	56	16		300kg
	56AX/N							400kg
301H	56AX/S	142	146	42	56	16		360kg
	56AX/N							450kg
305	56CX/S	161	146	42	75	16		700kg
307	56FJX/S	215	140	55	88	20		2000kg

## Folding Doors

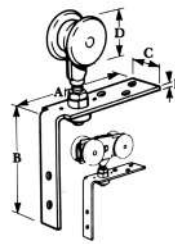

		21					
Track	Hanger Short Code	Dimensions					
		A	B	C	D	E	
290	21K/S						
	21K/N	153	153	25	37	5	
	21K/4N						
301	21A/S	178	153	38	56	6	
301H	21A/4S						
305	21C/S	178	153	38	56	6	

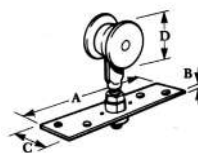

		61			
Track	Hanger Short Code	Dimensions			
		A	B	C	D
290	62K/S	140	5	25	37
301 and 301H	61A/S	184	6	38	56
	61C/S	184	6	38	75

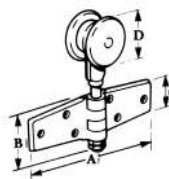

		62			
Track	Hanger Short Code	Dimensions			
		A	B	C	D
290	62K	180	77	45	37
301 & 301H	62A	180	77	45	56
	62C	540	104	51	75

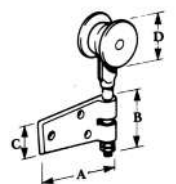

		63			
Track	Hanger Short Code	Dimensions			
		A	B	C	D
290	63K	90	77	45	37
301 & 301H	63A	90	77	45	56
	63C	203	104	51	75

## Fire Doors

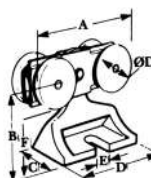

		56F						Max. Door Weight	
Track	Hanger Short Code	Dimensions							
		A	B	C	D	øD	E		F
301	56AF/S	142	70	45	50	56	16	42	300kg
301 & 301H	56AF/S	142	70	45	50	56	16	42	400kg
	56CF/S	161	89	45	83	75	17	51	700kg

# Industrial Channel and Rail Drawings

Dimensions (mm)

Component	89	94	97	100	900	99	13	917	918	297	298	299
A	25	20	38	27	29	38	60	13	10	65	51	51
B	24	21	27	27	45	46	65	35	25	55	51	32
C	3	1.5	3	3	2	3	3	2	2	7	4	3

For bracket specifications see technical datasheets at [www.pchenderson.com](http://www.pchenderson.com)

## Guide Channels

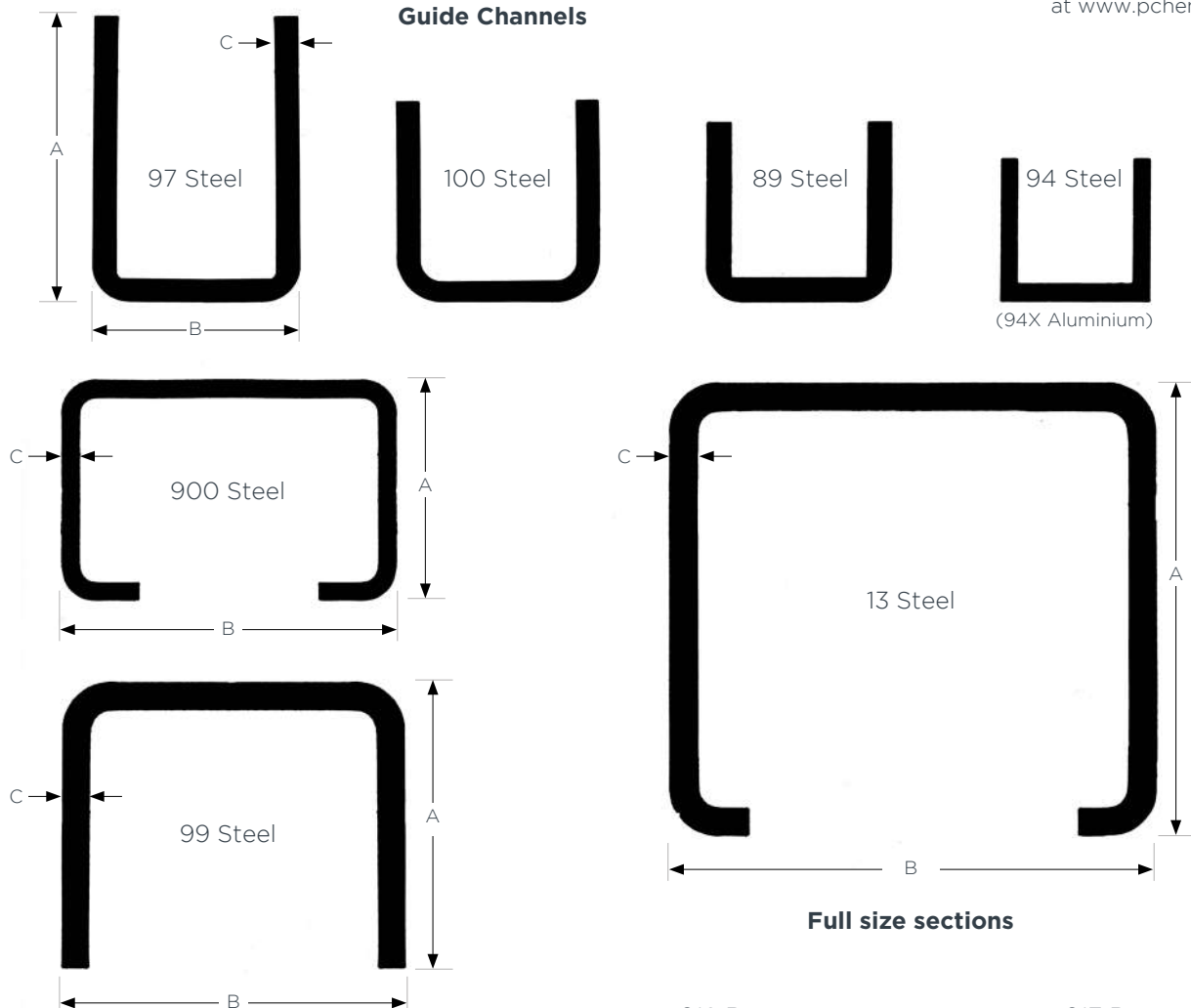

## Full size sections

## Floor Rails

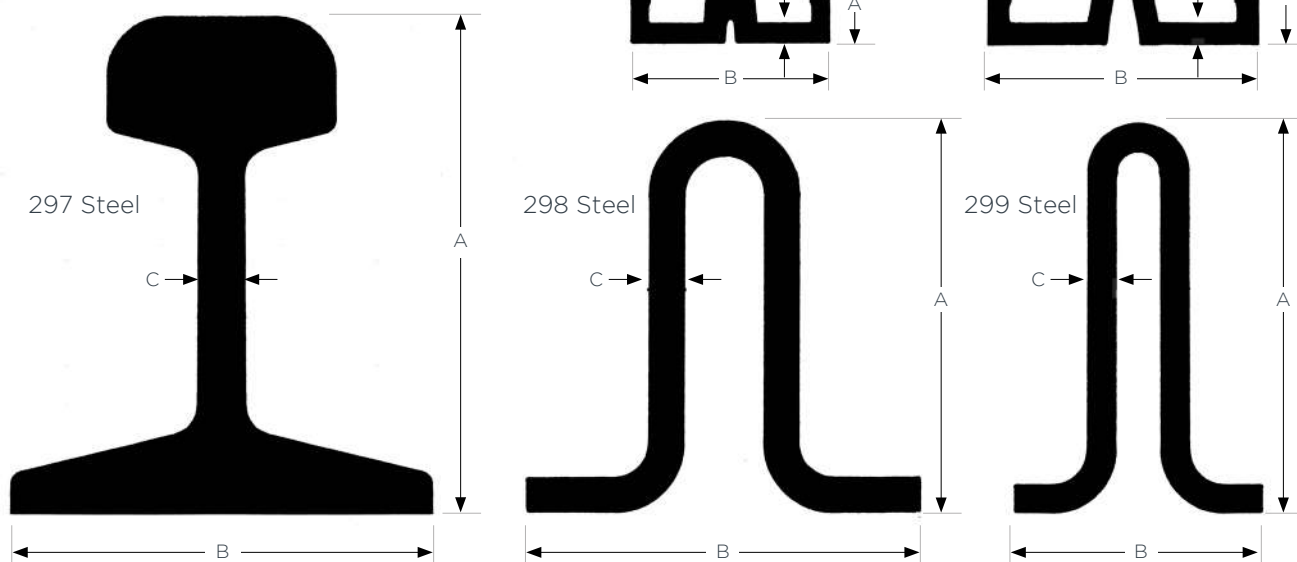

# Stainless Steel Component Drawings

For areas exposed to extreme levels of corrosive elements or where a high level of hygiene is essential, P C Henderson has developed a stainless steel range. Manufactured from high quality stainless steel and incorporating the latest polymers, the range can be used for a variety of applications including chemical factories, oil rigs, abattoirs, cold storage, food processing plants and areas exposed to salt water.

Stainless Steel product information can be found on pages 44 and 45.

## Stainless Steel Track, Guide Channel and Guide Drawings

### Track

Track	Dimensions (mm)			Capacities for Straight Sliding Doors		
	A	B	C	Door Thickness	Max. Door Height	Max. Door Weight
280/SS	28.5	31.7	1	20 - 50mm	2400mm	50/100kg
290/SS	45	39	1.5	35 - 48mm	3000mm	150kg
301/SS	68	56	2.5	43 - 57mm	3600mm	270kg

All track and channels are made out of grade 316L (A4) stainless steel and supplied in 2000 or 3000mm lengths.

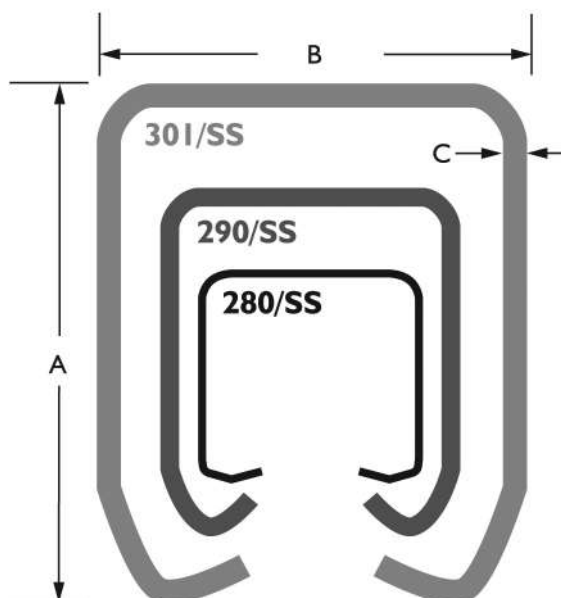

### Channel

Channel	Dimensions (mm)		
	A	B	C
89/SS	20.5	20	1.5

Guides and guide channels are essential for stability, safety and functioning of the system.

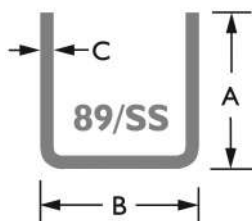

### Guides

#### 31S/SS

Made with grade 316 (A4) stainless steel angle with horizontal adjustable nylon guiding wheels on grade 304 (A2) stainless steel bolts. This guide provides unhindered access and is suitable for applications where dirt might enter the guide channel and hinder sliding.

Dimensions (mm)							
A	B	C	D	E	F	G	H
135	50	115	11	25	22	60	4

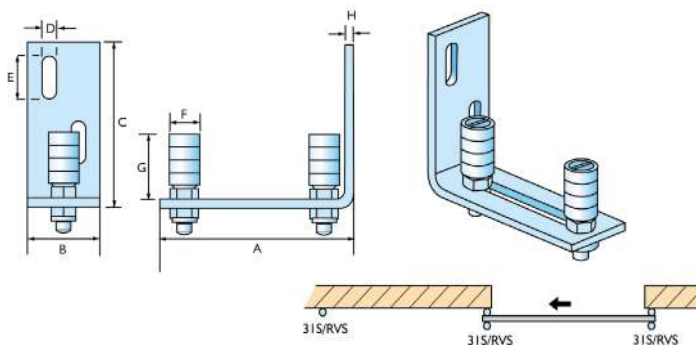

#### 89/2N/SS

Torpedo guide to be used in conjunction with 89/SS guide channel rebated in door or fixed to underside of door.

Dimensions (mm)							
A	B	C	D	E	F	G	H
9	16	150	80	35	48	54	25

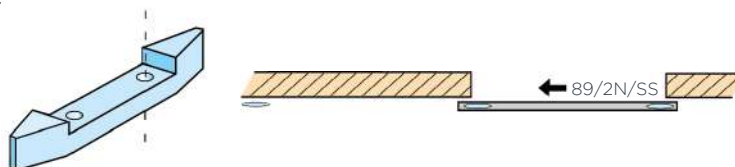

# Stainless Steel Bracket and Stop Drawings

The centre-to-centre distance of the brackets can vary depending on track length. Recommended spacing is 600mm and in case of maximum load 500mm.

Joining brackets are required at each track joint, the letter X donates the joining bracket.

It is recommended, should the stainless steel brackets or track be fitted directly to a material which is not of stainless steel, that a packing be placed between the two surfaced to avoid possible contact corrosion. All brackets are made in grade 316 (A4) stainless steel, all nuts and bolts in grade 304 (A2) stainless steel.

## Face Fixed Brackets

1/SS						
Short Code	Dimensions (mm)					Bolt
	A	B	C	D	E	
281/SS	20	7	28	40	-	M5
1/290/SS	86	20	50	42	25	M8
1/301/SS	110	27	66	66	33	M10

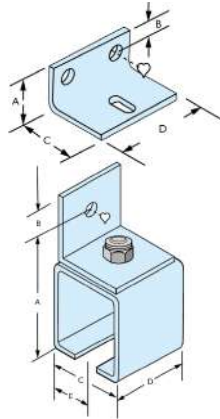

1X/SS						
Short Code	Dimensions (mm)					Bolt
	A	B	C	D	E	
1X/290/SS	86	20	50	100	25	M8
1X/301/SS	110	27	66	113	33	M10

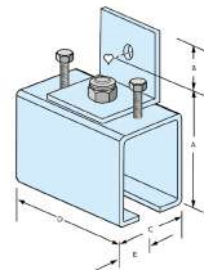

3/SS						
Short Code	Dimensions (mm)					Bolt
	A	B	C	D	E	
3/290/SS	76	-	88	40	65	M8
3/301/SS	99	-	136	60	106	M10

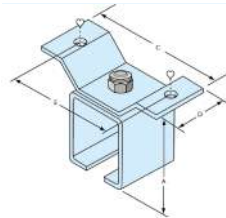

3X/SS						
Short Code	Dimensions (mm)					Bolt
	A	B	C	D	E	
3X/290/SS	76	-	88	40	65	M8
3X/301/SS	99	-	136	60	106	M10

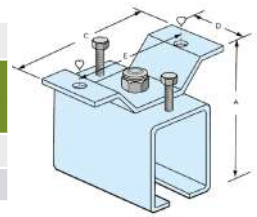

4/SS						
Short Code	Dimensions (mm)					Bolt
	A	B	C	D	E	
4/290/SS	76	-	40	88	65	M8
4/301/SS	99	-	60	136	106	M10

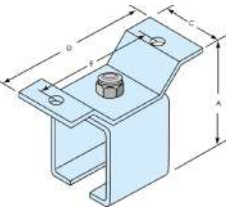

4R/SS					
Short Code	Dimensions (mm)				Bolt
	A	B	C	D	
4R/280/SS	50	50	37	39	M8
4R/290/SS	50	42	50	56	M10
4R/301/SS	65	66	66	80	M10

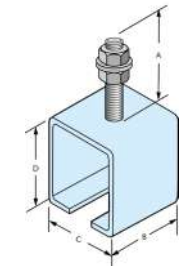

4X/SS					
Short Code	Dimensions (mm)				Bolt
	A	B	C	D	
4X/290/SS	-	100	50	56	M10
4X/301/SS	-	113	66	80	M12

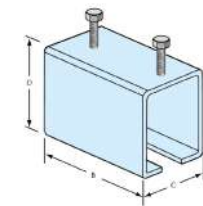

4RX/SS					
Short Code	Dimensions (mm)				Bolt
	A	B	C	D	
4RX/280/SS	50	50	37	39	M8
4RX/290/SS	50	100	50	56	M10
4RX/301/SS	65	113	66	80	M12

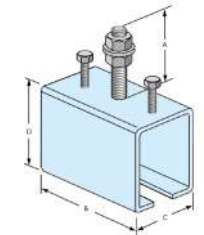

HH3/SS			
Short Code	Dimensions (mm)		
	A	B	C
HH3/290/SS	40	40	5
HH3/301/SS	40	40	5

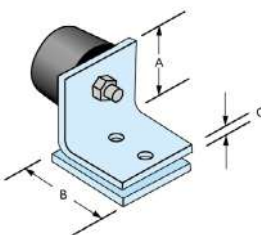

109/SS			
Short Code	Dimensions (mm)		
	A	B	C
109/SS	63	50	14

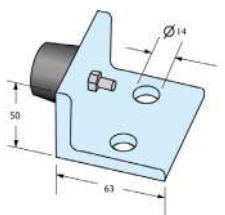



# Stainless Steel Hanger Drawings

## 284 and 285

Short Code	Track Type	Door Material	Dimensions (mm)					Max. Door Weight*
			A	B	C	D	∅	
284N/SS	280	Wood	62.5	27.5	21	80	8	50kg
285N/SS	280	Metal	62.5	27.5	-	-	8	50kg
284/SS	280	Wood	62.5	27.5	21	80	8	100kg
285/SS	280	Metal	62.5	27.5	-	-	8	100kg

Hanger body and wheels of high performance nylon. All metal components in grade 304 (A2) stainless steel.

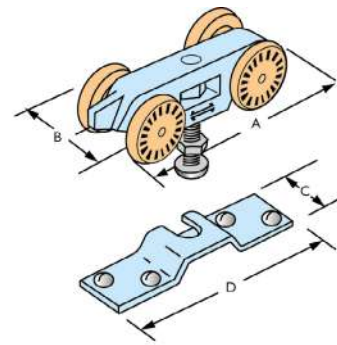

## 53

Short Code	Track Type	Door Material	Dimensions (mm)						Max. Door Weight*
			A	B	C	D	E	F	
53/290/SS**	290	Wood	87	180	77	37	43/58	3	150kg
53/301/SS***	301	Wood	135	180	77	49.5	43/53	3	270kg

\*\* Hanger body of high performance nylon. All other components in grade 304 (A2) stainless steel

\*\*\* Complete in grade 304 (a2) stainless steel

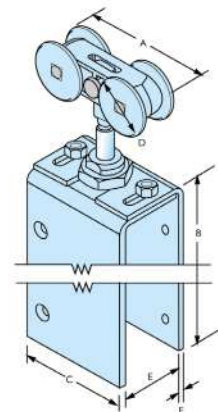

## 56

Short Code	Track Type	Door Material	Dimensions (mm)					Max. Door Weight*
			A	B	C	D	∅	
56/290/SS**	290	Metal	87	40	30	37	M10	150kg
56/301/SS***	301	Metal	135	78	43	49.5	M16	270kg

\*\*Hanger body of high performance nylon. All other components in grade 304 (A2) stainless steel

\*\*\* Complete in grade 304 (A2) stainless steel

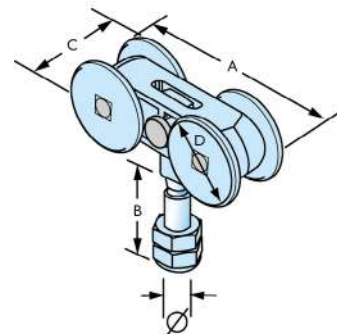

## 57

Short Code	Track Type	Door Material	Dimensions (mm)					Max. Door Weight*
			A	B	C	D	E	
57/290/SS**	290	Wood	87	39	187	3	37	150kg
57/301/SS***	301	Wood	135	39	187	3	49.5	270kg

\*\*Hanger body of high performance nylon. All other components in grade 304 (A2) stainless steel

\*\*\* Complete in grade 304 (A2) stainless steel

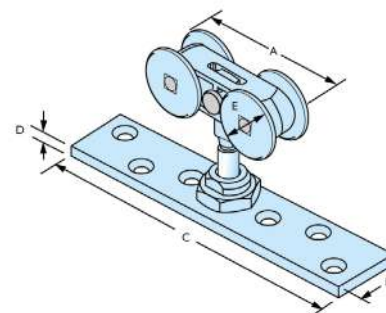

\*The maximum weight of each door carried by two hangers

# Accessories

Enhance your sliding or folding door hardware system by choosing from our wide range of accessories

## SOFT CLOSE KITS

Allow your doors to gently decelerate into position with one of our soft stop products.



### **Soltaire Soft Stop Kit**

For use with Soltaire 120

Short codes: 51SD80 | 51SD80D | 52SD80 | 52SD80D | 56SD80 | 56SD80D | 57SD80 | 57SD80D

See detailed specification information on pages 42 and 43.



### **Husky and Pocket Door Soft Stop Kit**

For use with Husky Sliding 100

Short codes: SOFT50 | SOFT50D | SOFT100

See detailed specification information on pages 30 and 31.



### **Velaro Soft Stop**

Complete Velaro kit with soft stop

Short codes: VS80/8 | VS80/10 | VS80/12 | VD80/8 | VD80/10 | VD80/12

See detailed specification information on page 28.



### **Rustic Soft Stop**

For use with Rustic 80

Short code: R80SOFT

## SIMULTANEOUS ACTION KITS

A great addition for bi-parting doors, pull one door open and the other one will open and close simultaneously.



### **Husky 100 Simultaneous Action Kit**

For use with existing or new Husky 100 products

Short code: SIM100

## SELF CLOSING DOOR KITS

Doors will automatically self-close after opening



### **Easyclose Automatic Door Closer**

Automatic door closer for doors up to 100kg

Short code: SC100



### **Marathon Self Closing Door Kit**

For use on doors weighing up to 60kg with any Marathon kit

Short code: SCK1

## LOW HEADROOM KITS

Designed to create a modern, minimalistic finish with all parts concealed. Low Headroom Kits can reduce the clearance between the bottom of the track and the top of the door to 2mm.



### Husky 100 Low Headroom Kit

To be used with the aluminium Husky 100 track.

Short code: LH100



### Soltaire Low Headroom Kit

To be used with Soltaire 120, 180 or 250.

Short codes: LH120A | LH180A | LH250A

See detailed specification information on pages 42 and 43.

## FIRE DOOR KITS

Developed as part of a half hour sliding fire door assembly to BS: 476: Part 22:1987 compliance



### Marathon Self Closing Fire Door Kit

To be used with Marathon 90

Short code: FDK1



### Marathon Non Self Closing Fire Door Kit

To be used with Marathon 90

Short code: FDK2

## FLUSH PULLS



### 26p

White plastic,  
ø40mm x 10mm (D)



### 385SA

Round, satin



### 414

Rectangular, aluminium self coloured, 133mm (H) x 60mm (W) x 23mm (D)



### 144B

Black oval, 144mm (h) x 44mm (w)



### 385PB

Round, polished brass



### 414SS

Rectangular, stainless steel, 133mm (H) x 60mm (W) x 23mm (D)

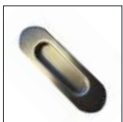

### 144S

Satin oval, 144mm (h) x 44mm (w)



### 400

Rectangular, SAA, 108mm (H) x 48mm (W) x 20mm (D)



### 414PSS

Rectangular, polished stainless steel, 133mm (H) x 60mm (W) x 23mm (D)



### 380SA

Satin, for edge of door



### 400SS

Rectangular, stainless steel, 100mm (H) x 48mm (W) x 14mm (D)



### 380PB

Polished brass, for edge of door



### 413

Heavy duty, zinc plated, cast iron, 152mm (H) x 95mm (W)

### FOR GLASS



### 27

Aluminium for Zenith, ø29mm overall, ø22mm cutting detail

## HANDLES



**463**  
Zinc plated, cast iron, 159mm (H) x 46mm (W)



**464**  
Zinc plated, case iron, 261mm (H) x 62mm (W)



**SF10S**  
Brushed stainless, for folding doors, 118mm (H) x 16mm (W) x 45mm (D)



**SF10G**  
PVD gold, for folding doors, 118mm (H) x 16mm (W) x 45mm (D)



**SF10C**  
Polished stainless, for folding doors, 118mm (H) x 16mm (W) x 45mm (D)



**SF10B**  
Black, for folding doors, 118mm (H) x 16mm (W) x 45mm (D)

## DOOR STOPS



**103**  
Floor mounted



**107**  
Zinc plated steel, double rubber buffers, floor or wall mounted



**107E**  
Rubber buffer



**109**  
Zinc plated steel, rubber buffer, floor or wall mounted



**110N**  
White nylon, rubber buffer



**28P**  
White nylon

## TRACK STOPS



**287**  
For Husky Sliding



**287SS**  
For Stainless Steel 280



**HH3/290**  
With rubber buffer for Straight Sliding 290 and Pacer track



**HH3/290SS**  
Stainless steel with rubber buffer for Stainless Steel 290



**HH3/301**  
With rubber buffer for Straight Sliding 301 and Flexirol track



**HH3/301SS**  
Stainless steel with rubber buffer, for Stainless Steel 301



**HH4/SS**  
Stainless steel with rubber buffer for Soltaire 120 track



**HH5/SS**  
Stainless steel with rubber buffer for Soltaire 180 and 250 track



## CLIP STOPS



**601H Clip Stop**  
For Husky Sliding



**601P**  
For Pacer Sliding

## DOOR MAGNETS



**MAG/B**  
Black magnet set for between doors



**SWMAG/B**  
Black magnet set for swing door



**MAG/C**  
Chrome magnet set for between doors



**SWMAG/C**  
Chrome magnet set for swing door



**MAG/G**  
Gold magnet set for between doors

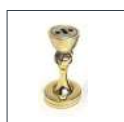

**SWMAG/G**  
Gold magnet set for swing door



**MAG/S**  
Satin magnet set for between doors



**SWMAG/S**  
Satin magnet set for swing door

## FLUSH BOLTS



**333**  
Satin anodised aluminium, 151mm (H) x 35mm (W)



**SF190L#**  
Lockable flush bolt, 190mm, available in gold, chrome, satin or black



**454**  
Satin anodised aluminium, 190mm (H) x 41mm (W)



**SF450L#**  
Lockable flush bolt, 450mm, available in gold, chrome, satin or black



**FB110S**  
Non locking, 110mm high, suitable for interior



**SF600L#**  
Lockable flush bolt, 600mm, available in gold, chrome, satin or black



**SF190#**  
Non lockable, 190mm, available in gold, chrome satin or black



**SF450#**  
Non lockable, 450mm, available in gold, chrome satin or black



**SF600#**  
Non lockable, 600mm, available in gold, chrome satin or black

Replace # with first letter of colour for full short code - gold, black, satin or chrome

## LOCKS



**390SA**  
Satin for 30 - 38mm thick doors



**390PB**  
Gold for 30 - 38mm thick doors



**430**  
Detachable locking bar for use with a padlock



**431**  
Swivel locking bar for use with a padlock



**395SA**  
Satin 40 - 48mm thick doors



**395PB**  
Gold 40 - 48mm thick doors



**TWB/MLS**  
Twinbolt Locking Handle for use with Securefold, locks doors internally by turning one handle 90 degrees

### FOR GLASS DOORS



**507**  
Cylinder lock to fit on the left or right hand edge of Zenith glass panel

## BOLTS



**994**  
Bolt with electro galvanised steel shoots and guides with socket for concrete when required



**994X**  
Offset bolt with zinc galvanised steel shoot & guides with socket for concrete



**F3715**  
Surface fixed bolt in satin



**994R/89**  
Galvanised steel roller guide bolt 380mm for 89 channel



**994R/97**  
Galvanised steel roller guide bolt 380mm for 96 channel



**F3734**  
Keep for F3715 bolt

## AUTOMATIC DOOR ACCESSORIES



**E2/RCK**  
Remote Control Kit - includes a single channel remote control and one wireless receiver control panel



**ER/\***  
Radar Motion Sensor - available in black (ER/B), white (ER/W) or aluminium (ER/S)

# FASCIA



## F134/\*\*\*\*

For Husky and Double Top. Available in 2000, 2500, 3000 and 4000mm lengths



## F134/ECP

End cap pack for use with F134 Fascia

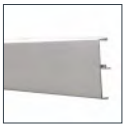

## F138/\*\*\*\*

For doors up to 25mm thick. In 1500, 2000, 2500, 3000 & 4000mm lengths.



## F138/ECP

End cap pack for use with F138 fascia.



## F140/\*\*\*\*

For Husky aluminium track, face fixing. Available in 2000, 3000, 4000 and 6000mm lengths.



## F140ECP

End cap pack for use with F140 Fascia



## F160/\*\*\*\*

For use with Pacer soffit fixed track. Available in 2000, 2500, 3000, 4000 and 6100mm lengths.



## F160/ECP

End cap pack for use with F160 Fascia

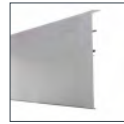

## F200/\*\*\*\*

For Pacer face fixed track. In 2000, 2500, 3000, 3500, 4000 and 6000mm lengths.



## F200/ECP End Cap Pack

End cap pack for use with F200 Fascia

### FOR GLASS DOORS



## F136/\*\*\*\*

For Husky Glass. Available in 1800, 2000, 2500, 3000 and 4000mm lengths



## F136/ECP

End cap pack for use with F136 Fascia



## F200X/\*\*\*\*

For Pacer Glass face fixed track. Available in 2000, 2500, 3000, 3500 and 6100mm lengths



## F200/ECP

End cap pack for use with F200X Fascia.





Global leaders in  
the design and  
manufacture of  
hardware systems  
for sliding and  
folding doors



P C Henderson Limited, Durham Road, Bowburn,  
Co. Durham, DH6 5NG, United Kingdom

# HENDERSON

#### UK Sales

t: +44 (0) 191 377 7345  
e: [sales@pchenderson.com](mailto:sales@pchenderson.com)  
w: [www.pchenderson.com](http://www.pchenderson.com)

#### Export Sales

t: +44 (0) 191 377 7346  
e: [international@pchenderson.com](mailto:international@pchenderson.com)  
w: [export.pchenderson.com](http://export.pchenderson.com)

